

HANDLES

PULLS

KNOBS









HANDLES (BACK SCREW MOUNT)

Picture	Item Name	Page	Picture	Item Name	Page
	PXB-AC09-128 NEW	11-1		DL-SUS304 STAINLESS 304 STEEL	18
	PXB-AS09-128 NEW	11-1		KB-SUS304 STAINLESS 304 STEEL	19
	PXB-AC08-111 NEW	11-2		DS-SUS304 STAINLESS 304 STEEL	19
	PXB-AS08-111 NEW	11-2		DL STAINLESS 303 STEEL	20
	H-35 NEW	11-10		DS STAINLESS 303 STEEL	20
	H-29 NEW	11-10		KB STAINLESS 303 STEEL	21
	CJH NEW	11-12		EC STAINLESS 304 STEEL	21
	SJH NEW	11-13		ECH STAINLESS 303 STEEL	22
	ZL-2001 STAINLESS 316 STEEL	12		FB STAINLESS 304 STEEL	22
	ZL-2002 STAINLESS 316 STEEL	13		H-42-C STAINLESS 304 STEEL	23
	ZL-2301 STAINLESS 316 STEEL	13		T-100-8 STAINLESS 304 STEEL	23
	EK-S STAINLESS 316 STEEL	14		LF-12 STAINLESS 304 STEEL	24
	KC-S STAINLESS 316 STEEL	14		H-75-C STAINLESS 304 STEEL	24
	KC-R STAINLESS 316 STEEL	15		H-42-Z STAINLESS 304 STEEL	24
	XL-JS STAINLESS 316 STEEL	15		SWP STAINLESS 316 STEEL	25
	XL-JSR STAINLESS 316 STEEL	16		SWF STAINLESS 316 STEEL	25
	EK-R STAINLESS 316 STEEL	16		H-42-CT	25
	LX STAINLESS 304 STEEL	17		KPH STAINLESS 304 STEEL	26
	XL-CU STAINLESS 303 STEEL	17		40 SERIES STAINLESS 304 STEEL	26
	XL-CUR STAINLESS 303 STEEL	18		DSI-110 STAINLESS 304 STEEL	26













Picture	Item Name		Page
	DSI-120	STAINLESS 304 STEEL	27
	50 SERIES	STAINLESS 304 STEEL	27
	30 SERIES	STAINLESS 304 STEEL	27
	82 SERIES	STAINLESS 304 STEEL	28
	90 SERIES	STAINLESS 304 STEEL	28
	I1020	STAINLESS 304 STEEL	29
	DIH	STAINLESS 304 STEEL	29
	I1014	STAINLESS 304 STEEL	29
	LX-110	BRASS	36
	TMH	BRASS	36
	K255	BRASS	37
	K259	BRASS	37
	122HD	BRASS	38
	K281	BRASS	38
	ATO	BRASS	39
	OPE-110	BRASS	39
	MRB-A	BRASS	40
	DLB	BRASS	40
	KAKU	BRASS	41
	HIRA	BRASS	41













Picture	Item Name	Page
	SAZ-121CR	42
	SAZ-122	42
	AKH	43
	936	43
	XLA-HA	44
	KM-96	44
	KMH	45
	MJH	46
	KK-H	47
	KK-M	47

HANDLES (FRONT SCREW MOUNT)		
Picture	Item Name	Page
	FT-R NEW	11-11
	FT-T NEW	11-11
	2LC	STAINLESS 316 STEEL 30
	4LC	STAINLESS 316 STEEL 30
	EC-Y	STAINLESS 303 STEEL 31
	EC-H	STAINLESS 303 STEEL 31
	FT-65, FT-80, FT-100	STAINLESS 304 STEEL 32
	FT-120, FT-150	STAINLESS 304 STEEL 32

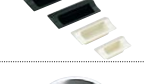
Picture	Item Name		Page
	FT-110S	STAINLESS 304 STEEL	33
	XL-CUY	STAINLESS 303 STEEL	33
	FT-200, FT-280	STAINLESS 316 STEEL	34
	FT-S280	STAINLESS 316 STEEL	34
	MG	STAINLESS 316 STEEL	35
	US	STAINLESS 304 STEEL	35

RECESSED PULL

Picture	Item Name		Page
	HH-UD NEW		11-14
	ZL-2501	STAINLESS 316 STEEL	50
	YK-70	STAINLESS 304 STEEL	51
	YK-W100	STAINLESS 304 STEEL	51
	SKH	STAINLESS 304 STEEL	51
	HH-M	STAINLESS 304 STEEL	52
	UTA-105	STAINLESS 304 STEEL	53
	UT	STAINLESS 304 STEEL	54
	HH-D	STAINLESS 316 STEEL	54
	HH-K	STAINLESS 316 STEEL	54
	HH-DS114	STAINLESS 316 STEEL	55
	HH-KS114	STAINLESS 316 STEEL	55

Picture	Item Name		Page
	HH	STAINLESS 304 STEEL	56
	HH-AS2	STAINLESS 304 STEEL	56
	SD-160		57
	UTZ-130		57
	UP-600		58
	5103		58
	HH-JS		59
	HH-JW		59
	SMH	STAINLESS 304 STEEL	60
	OP-150	STAINLESS 304 STEEL	60
	HN	STAINLESS 304 STEEL	60
	XLA-HHA		61
	HH-P135		61

PULL

Picture	Item Name		Page
	SN	STAINLESS 304 STEEL	48
	SND	STAINLESS 304 STEEL	48
	ANGU	BRASS	49
	CHAN	BRASS	49
	FH-100AK, FH-100BK		62

Picture	Item Name	Page
	FH-100AM, FH-100BM	63
	SD	75
	HS	75
	RD	75
	AOT35	77
	GF-100	77
	RD	83
	SU-T	87

HATCH PULL

Picture	Item Name	Page
	ST-90, 115	62
	ST-80, 100	62
	HR	63
	HR-RS	63
	26900	64
	26901	64
	26700	64
	980640	65
	980641, 980642	65
	980643	65







































Picture	Item Name	Page
	587	66
	587B	66
	580	67

TRUNK HANDLE





















Picture	Item Name	Page
	PS	67
	HCT-150	68
	TMU-115	68
	MUD-140	69
	PT-148	69







KNOB

Picture	Item Name	Page
	ZL-1901	70
	ZL-1902	70
	ZL-1903	71
	ZL-1904	71
	ZL-1905	72
	ZL-2302	72
	ZL-2503	73
	ZL-1910	73

Picture	Item Name		Page	Picture	Item Name		Page
	RS-38S	STAINLESS 304 STEEL	74		KHE101-30	BRASS	82
	RSS	STAINLESS 304 STEEL	74		MKZ		83
	CU-L-35	STAINLESS 303 STEEL	75		KM-130		84
	KK-T		76		SGL		84
	KK-B		76		GD-20		84
	EXSEL		77		FS-04-S		85
	TMT	BRASS	78		FS-06-S		85
	GLA	BRASS	78		UIB		85
	MRB	BRASS	78		UIA		85
	MBT-12	BRASS	79		UID-20		86
	DW-50N	BRASS	79		215F		86
	DW-50	BRASS	79		231F, 232F, 217F		86
	KHE103	BRASS	80		229F		86
	SY	BRASS	80		SMT		87
	TS	BRASS	80		SMRB		87
	B046	BRASS	81	PUSH KNOB			
	B671	BRASS	81		ZL-1908	STAINLESS 316 STEEL	88
	KHE102	BRASS	81		PK03		89
	KHE107	BRASS	82		PK04		89
	KHE111	BRASS	82				

DOOR HANDLE

Picture	Item Name	Page
	SBH NEW	11-3
	TBH NEW	11-4
	MTH NEW	11-5
	APH NEW	11-5
	MSH NEW	11-6
	AGH-L / AGH-T NEW	11-7
	AGH-F NEW	11-8
	ALH NEW	11-9
	SYH NEW	11-9
	HGH NEW	11-10
	ZL-1501 STAINLESS 316 STEEL	90-91
	ZL-1502 STAINLESS 316 STEEL	92-93
	ZL-1506 STAINLESS 316 STEEL	94-95
	MP STAINLESS 316 STEEL	96
	RH-760 STAINLESS 303 STEEL STAINLESS 304 STEEL	96
	SSH STAINLESS 304 STEEL	97
	SOR	97
	MDH STAINLESS 304 STEEL	98
	DTM-B BRASS	99
	DSI-4253 STAINLESS 304 STEEL	104

Picture	Item Name	Page
	DSI-3250 STAINLESS 304 STEEL	104
	DSI-4251 STAINLESS 304 STEEL	105
	DSI-3330 STAINLESS 304 STEEL	105
	DSI-2000 STAINLESS 304 STEEL	106
	DSI-3310 STAINLESS 304 STEEL	107
	DSI-4400 STAINLESS 304 STEEL	107
	DSI-1630 STAINLESS 304 STEEL	108

DOOR KNOB

Picture	Item Name	Page
	ZL-1503 FOR GLASS DOORS STAINLESS 316 STEEL	100
	ZL-2502 FOR GLASS DOORS STAINLESS 316 STEEL	100
	ZL-1504 FOR GLASS DOORS STAINLESS 316 STEEL	101
	ZL-1505 FOR GLASS DOORS STAINLESS 316 STEEL	101
	ZL-1909 FOR GLASS DOORS STAINLESS 316 STEEL	102
	ZL-1907-24 FOR GLASS DOORS STAINLESS 316 STEEL	102
	ZL-1906 FOR GLASS DOORS STAINLESS 316 STEEL	103
	GT-40CR FOR GLASS DOORS BRASS	103

STAINLESS STEEL HANDLE SERIES

HANDLES,
PULLS & KNOBS

STAINLESS STEEL HANDLE SERIES

XL-JSR (P.16)

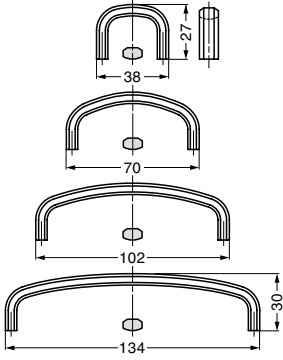

XL-CUR (P.18)

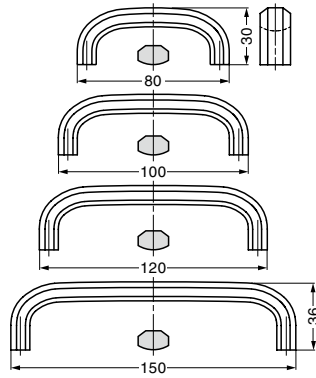

EK-R (P.16)

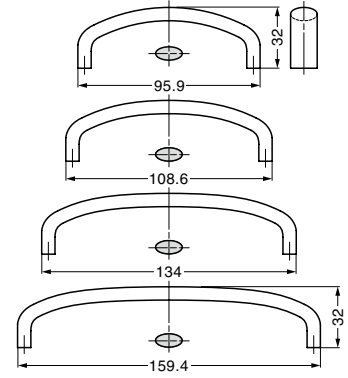

XL-CU (P.17)

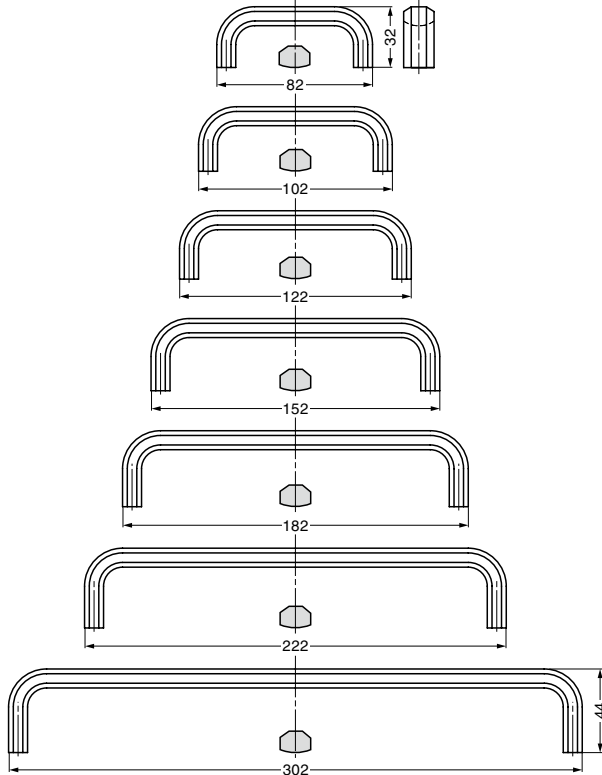

DS (P.20)

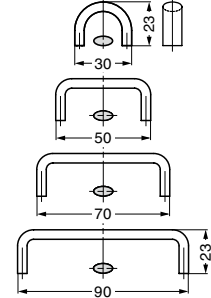

DL (P.20)

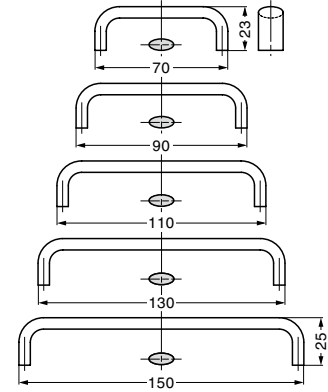

XL-JS (P.15)

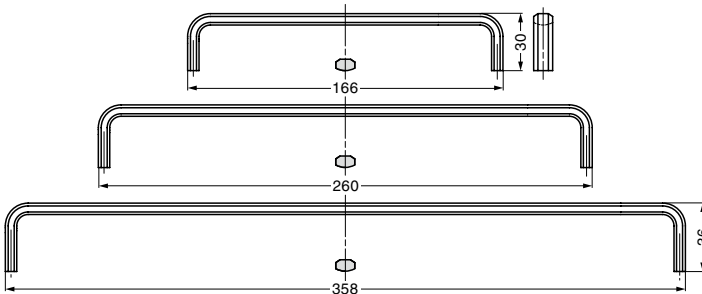

Approx. 100 mm

STAINLESS STEEL HANDLE SERIES

HANDLES,
PULLS & KNOBS

STAINLESS STEEL HANDLE SERIES

FB (P.22)

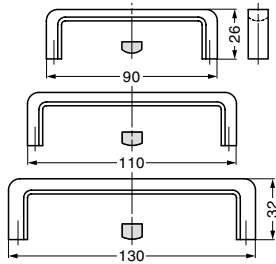

KB (P.21)

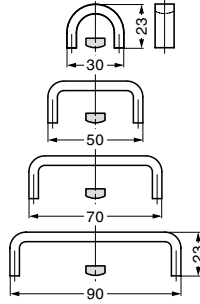

LX (P.17)

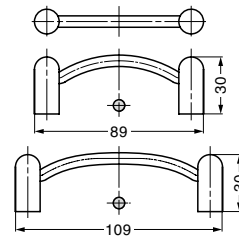

EC (P.21)

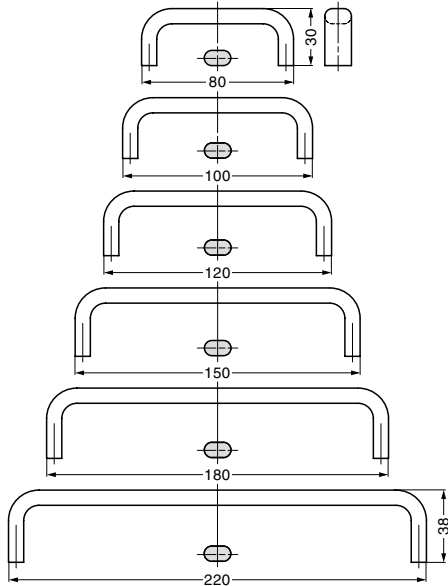

T-100-8 (P.23)

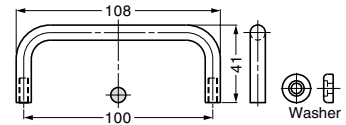

H-42-C (P.23)

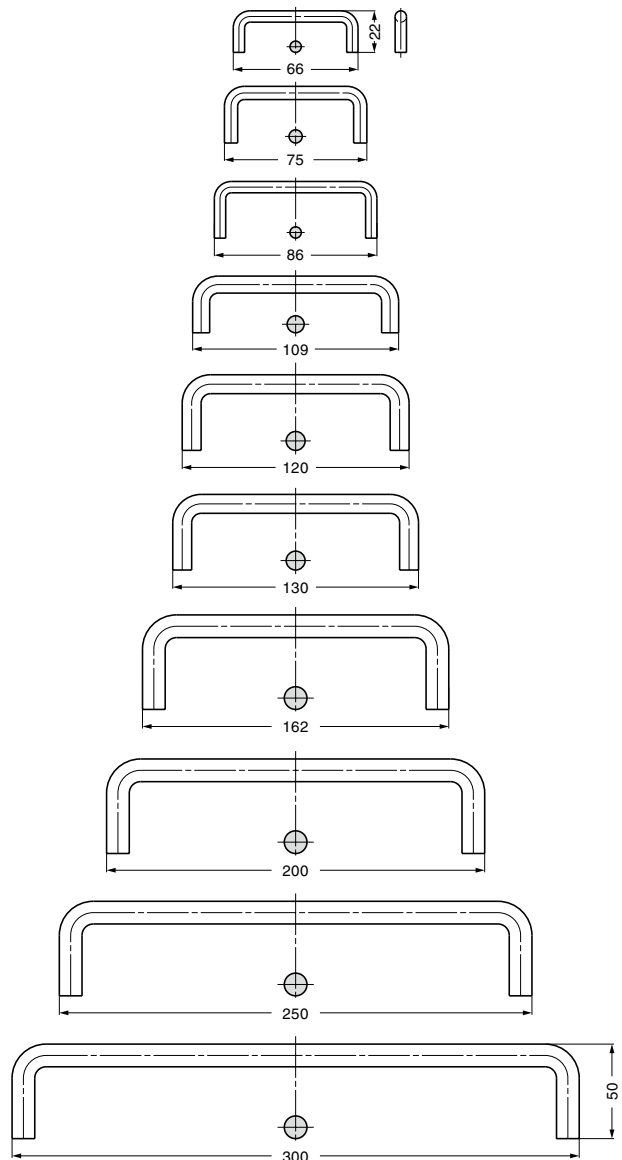

ECH (P.22)

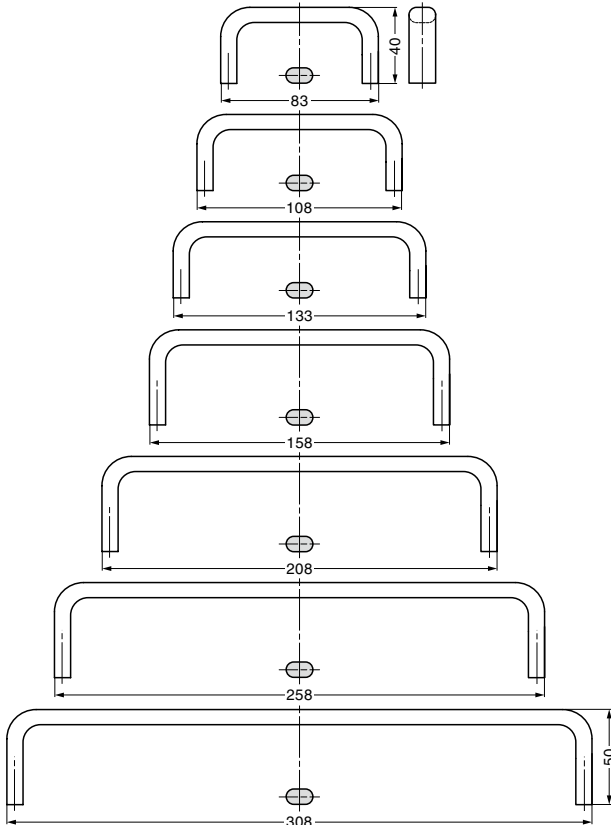

Approx. 100 mm

STAINLESS STEEL HANDLE SERIES

HANDLES,
PULLS & KNOBS

STAINLESS STEEL HANDLE SERIES

H-75-C (P.24)

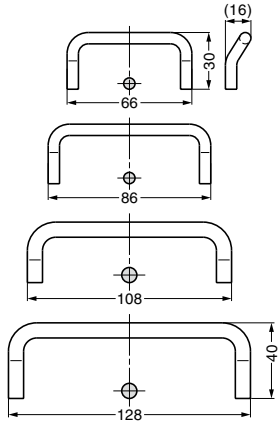

LF-12 (P.24)

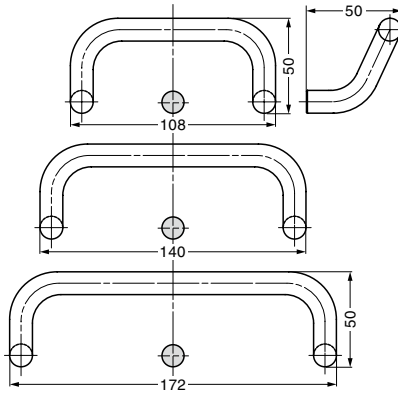

4LC (P.30)

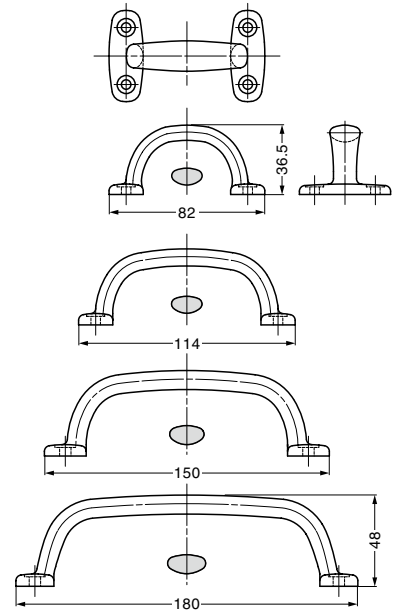

2LC (P.30)

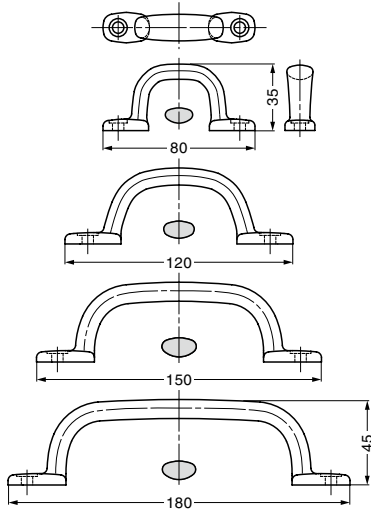

XL-CUY (P.33)

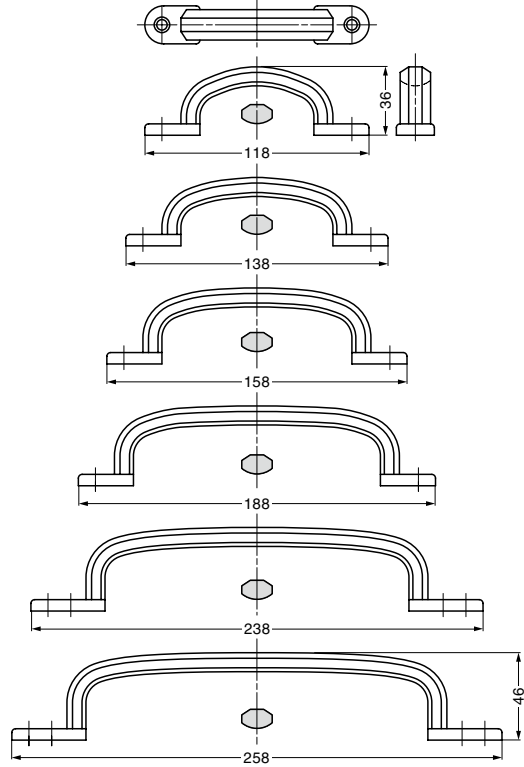

Approx. 100 mm

STAINLESS STEEL HANDLE SERIES

FT-65, FT-80, FT-100 (P.32)

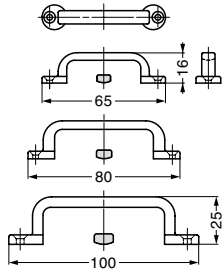

FT-110S (P.33)

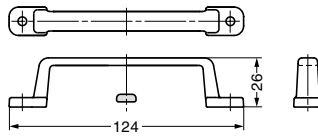

US (P.35)

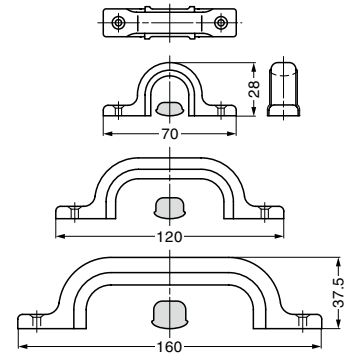

FT-120, FT-150 (P.32)

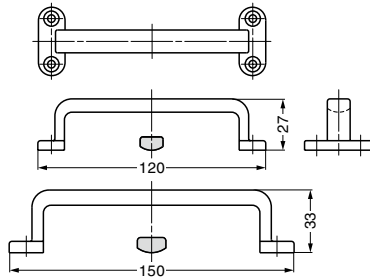

EC-Y (P.31)

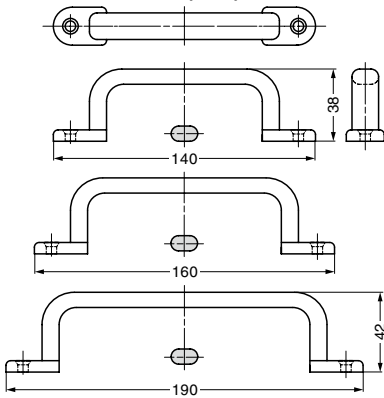

EC-H (P.31)

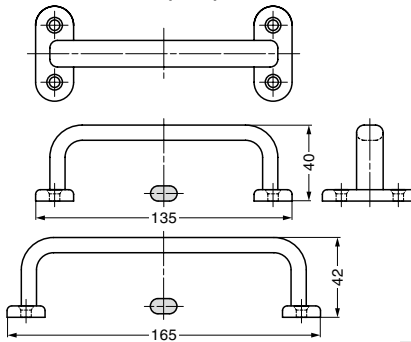

MG (P.35)

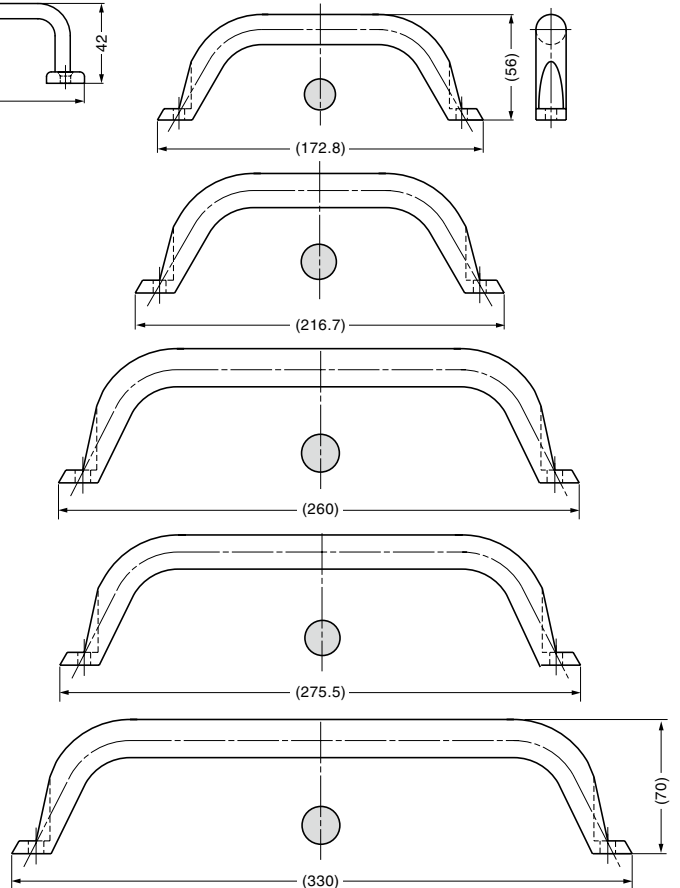

FT-200, FT-280 (P.34)

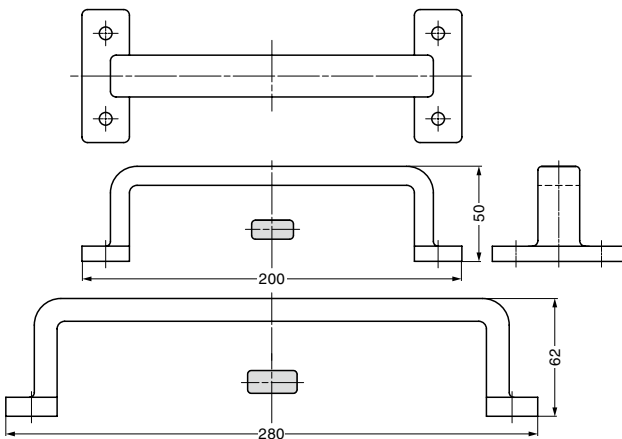

Approx. 100 mm

HANDLE (AGED CAST SERIES)

TEST
METHOD 1

PXB-AC09-128



Black Bronze

Brown Bronze



Generous amounts of brass cast into a nostalgic and rugged finish.

Features

A wide array of matching products is available, allowing for total design coordination.

Remarks

The finish of the products varies as the finishing process works with the natural characteristics of the material.

Parts Included

Size M4 x 30 truss head cross-recessed screws (stainless steel)

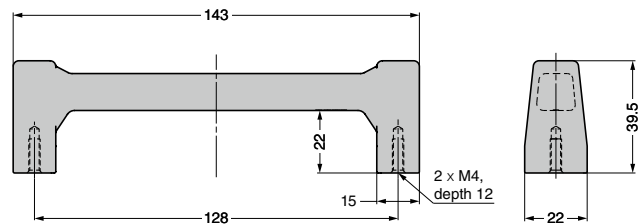

CAD	Item Code	Item Name	Material	Colour	Load Capacity N	Load Capacity kgf	Weight (g)	Box (pcs)	Carton (pcs)
	100-033-726	PXB-AC09-128-BL	Brass	Black Bronze	500	51	350	4	16
	100-033-727	PXB-AC09-128-BR		Brown Bronze					

HANDLE (AGED SCREW SERIES)

TEST
METHOD 1

PXB-AS09-128



Brown Bronze

Clear Bronze



Generous amounts of brass cast into a nostalgic and rugged finish. Slotted front installation screws, influenced by old-fashioned American interiors.

Features

A wide array of matching products is available, allowing for total design coordination.

Remarks

- The finish of the products varies as the finishing process works with the natural characteristics of the material.
- The slotted screws are for decoration only. Use the included screws to mount this product.

Parts Included

Size M4 x 30 truss head cross-recessed screws (stainless steel)

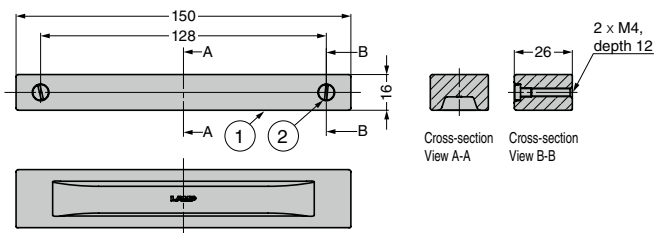

CAD	Item Code	Item Name	Material	Colour	Load Capacity N	Load Capacity kgf	Weight (g)	Box (pcs)	Carton (pcs)
	100-033-736	PXB-AS09-128-BR	Brass	Brown Bronze	500	51	319	5	30
	100-033-737	PXB-AS09-128-SD		Clear Bronze					

KNOB (AGED CAST SERIES)

PXB-AC08-111



Black Bronze



Brown Bronze



Generous amounts of brass cast into a nostalgic and rugged finish.

Features

A wide array of matching products is available, allowing for total design coordination.

Remarks

The finish of the products may differ significantly as the finishing process works with the natural characteristics of the material.

Parts Included

Size M4 x 30 truss head cross-recessed screws (stainless steel)

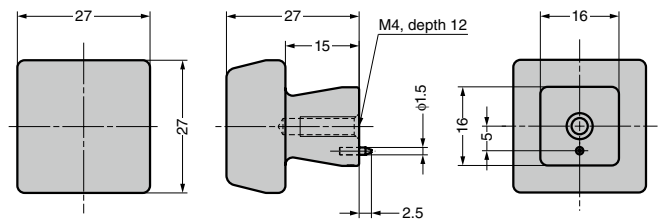

CAD	Item Code	Item Name	Material	Colour	Weight (g)	Box (pcs)	Carton (pcs)
	100-033-724	PXB-AC08-111-BL	Brass	Black Bronze	91	10	80
	100-033-725	PXB-AC08-111-BR		Brown Bronze		10	80

KNOB (AGED SCREW SERIES)

PXB-AS08-111



Brown Bronze



Clear Bronze



Generous amounts of brass cast into a nostalgic and rugged finish. Slotted front installation screws, influenced by old-fashioned American interiors.

Features

A wide array of matching products is available, allowing for total design coordination.

Remarks

- The finish of the products may differ significantly as the finishing process works with the natural characteristics of the material.
- The slotted screws are for decoration only. Use the included screws to mount this product.

Parts Included

Size M4 x 30 truss head cross-recessed screws (stainless steel)

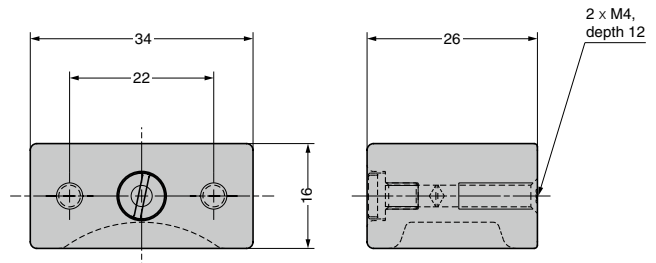

CAD	Item Code	Item Name	Material	Colour	Weight (g)	Box (pcs)	Carton (pcs)
	100-033-734	PXB-AS08-111-BR	Brass	Brown Bronze	106	10	80
	100-033-735	PXB-AS08-111-SD		Clear Bronze		10	80

DESIGN HANDLE (OFFSET TYPE)

SBH



Features

- A firm feeling similar to gripping wood.
- Ergonomically designed handle fits naturally to regular grip.
- When seen from the front, the handle appears to be floating.

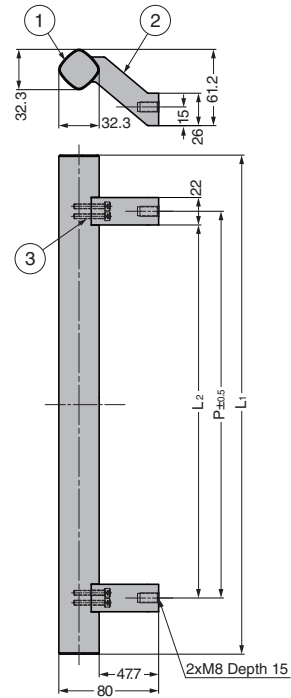

No.	Part Name	Material	Finish
①	Bar	Aluminium Alloy	Matte Silver/Anodised (SL) Matte Black/Anodised (BL)
②	Bracket	Zinc Alloy (ZDC)	Paint/Black
③	Hexagon Socket Head Bolt M4x35	Stainless steel	-

CAD	Item Code	Item Name	Finish	L ₁	L ₂	P	Load Capacity N	Load Capacity kgf	Weight (g)	Box (pcs)	Carton (pcs)
2D/3D	100-036-952	SBH-400SL	Matte Silver/Anodised	400	288	310	-	-	1079	1	5
2D/3D	100-036-953	SBH-400BL	Matte Black/Anodised							1	5
2D/3D	100-036-954	SBH-600SL	Matte Silver/Anodised	600	488	510			1456	1	5
2D/3D	100-036-955	SBH-600BL	Matte Black/Anodised							1	5
2D/3D	100-036-956	SBH-800SL	Matte Silver/Anodised	800	688	710			1833	1	5
2D/3D	100-036-957	SBH-800BL	Matte Black/Anodised							1	5

DESIGN HANDLE (STRAIGHT TYPE)

TBH

HANDLES,
PULLS & KNOBS

DESIGN HANDLE (STRAIGHT TYPE)

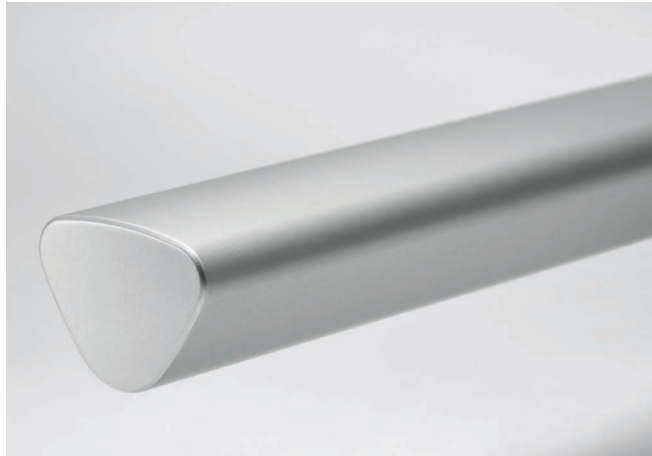

Features

- Unique design type creates the firm feeling of gripping wood.
- Consists of a triangular bar and a bracket in the center.

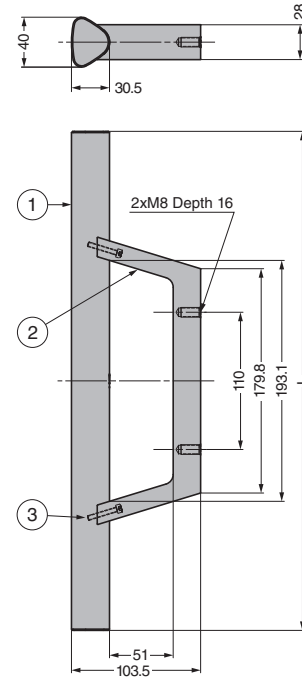

No.	Part Name	Material	Finish
①	Bar	Aluminium Alloy	Matte Silver/Anodised (SL) Matte Black/Anodised (BL)
②	Bracket	Zinc Alloy (ZDC)	Paint/Black
③	Hexagon Socket Head Bolt M4x35	Stainless steel	-

CAD	Item Code	Item Name	Bar / Finish	L	Load Capacity N	Load Capacity kgf	Weight (g)	Box (pcs)	Carton (pcs)
2D/3D	100-036-948	TBH-400SL	Matte Silver/Anodised	400	-	-	1877	1	5
2D/3D	100-036-949	TBH-400BL	Matte Black/Anodised					1	5
2D/3D	100-036-950	TBH-600SL	Matte Silver/Anodised	600	-	2363	1	5	
2D/3D	100-036-951	TBH-600BL	Matte Black/Anodised				1	5	

ALUMINIUM PIPE HANDLE

LOAD
CAPACITY 500 NTEST
METHOD 1

MTH

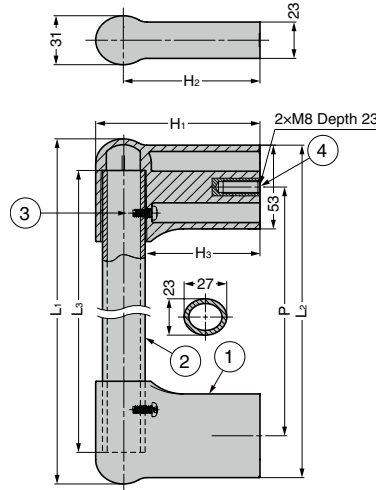

Features

- Position of bracket (MTH-T) is higher than common handles, suitable for inset sliding door of machine tool.
- MTH-L with the same height as common handles for total coordination with handle of machine tool.
- Pipe and bracket are connected with screws, preventing pipe loosening and idling.
- Elliptical pipe shape allows for easy gripping and sliding.

Remarks

For single-sided mount. Cannot be used for double-sided mount.

Recommended Screws

M8 screw

No.	Part Name	Material	Finish / Colour
①	Bracket	Glass Filled Polyamide	Black
②	Pipe	Aluminium Alloy	Anodised Silver
③	Countersunk head tapping screw 5x12	Steel	Coloured Zinc Chromate (Trivalent)
④	Nut	Brass	Plain

CAD	Item Code	Item Name	L ₁	L ₂	L ₃	P	H ₁	H ₂	H ₃	Load Capacity N	Load Capacity kgf	Weight (g)	Box (pcs)	Carton (pcs)
2D/3D	100-032-610	MTH-L300	360	352	320	300				500	51	360	1	15
2D/3D	100-032-611	MTH-L450	510	502	470	450	74	56.5	43			445	1	15
2D/3D	100-032-612	MTH-L600	660	652	620	600						530	1	15
2D/3D	100-032-613	MTH-T300	360	352	320	300						430	1	15
2D/3D	100-032-614	MTH-T450	510	502	470	450	104	86.5	73			515	1	15
2D/3D	100-032-615	MTH-T600	660	652	620	600						600	1	15

ALUMINIUM PIPE HANDLE

APH



Features

- Possible to fix with screws from the front.
- 4 lengths of pipes are available. By cutting the pipe, the handle length can be changed freely.
- Other handle sizes are possible at surcharge. For lot quantity and available lengths, please contact local representatives.
- High precision assembly of pipe and bracket.

Remarks

- Push the pipe in strongly when assembling to suppress looseness.
- For single-sided mount. Cannot be used for double-sided mount.

Recommended Screws

- Countersunk head screw M8

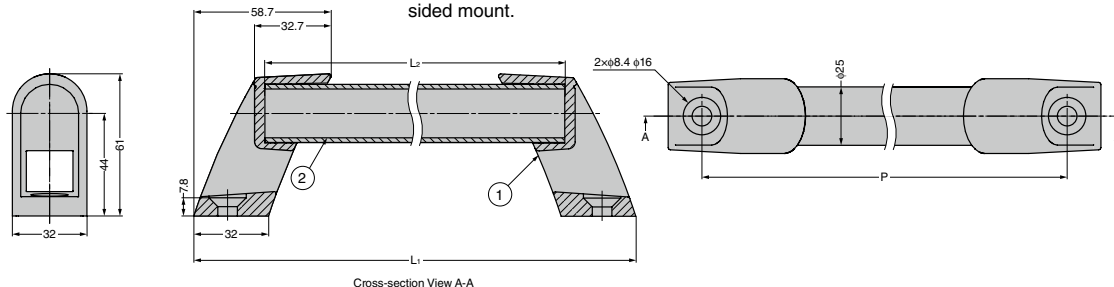

Cross-section View A-A

Bracket

CAD	Item Code	Item Name	Weight (g)	Box (pcs)	Carton (pcs)
2D/3D	100-029-942	APH-B	34	150	600

No.	Part Name	Material	Finish / Colour
①	Bracket	PA	Black
②	Pipe	Aluminium Alloy	Anodised Silver

Pipe

CAD	Item Code	Item Name	L ₁	L ₂	P	Weight (g)	Box (pcs)	Carton (pcs)
2D/3D	100-035-462	APH-P300	328.9	268	300	104.8	130	-
2D/3D	100-035-463	APH-P400	428.9	368	400	119.3	100	-
2D/3D	100-035-464	APH-P500	528.9	468	500	133.7	70	-
2D/3D	100-035-465	APH-P600	628.9	568	600	287.9	70	-

DESIGN HANDLE (STRAIGHT TYPE)

MSH

HANDLES,
PULLS & KNOBS

DESIGN HANDLE (STRAIGHT TYPE)

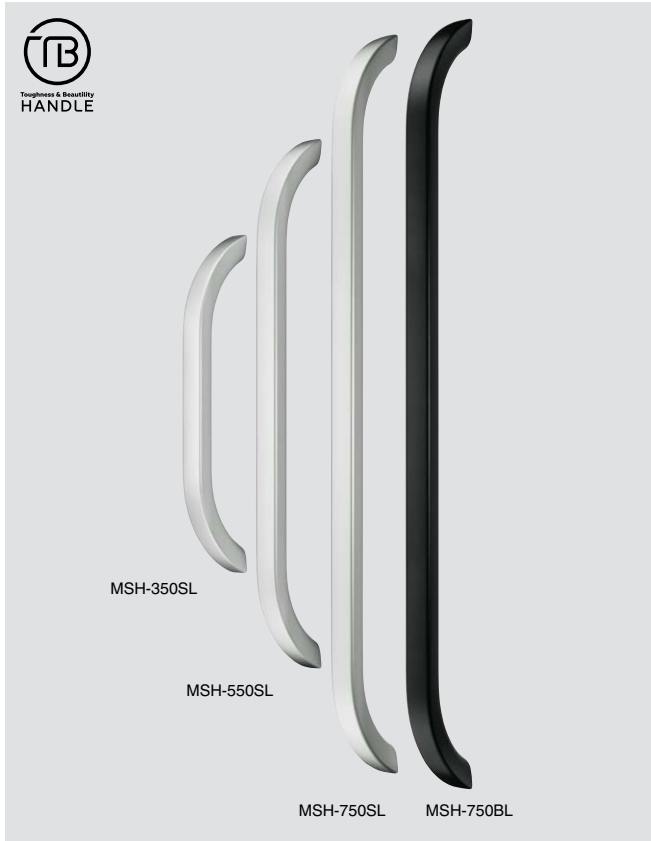

Features

- Flat surface creates a refined impression.
- A beautifully simple design with weight and size that provides a firm and comfortable grip.

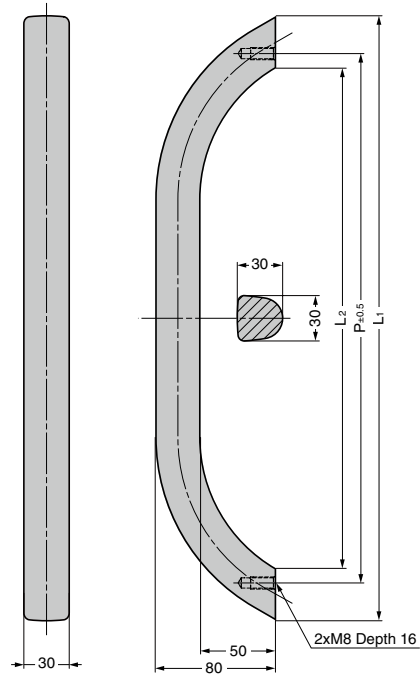

CAD	Item Code	Item Name	Material	Finish	L ₁	L ₂	P	Load Capacity N	Load Capacity kgf	Weight (g)	Box (pcs)	Carton (pcs)
	100-036-942	MSH-350SL	Aluminium Alloy	Matte Silver/Anodised	400	330.7	350	500	51	850	5	—
	100-036-943	MSH-350BL		Matte Black/Anodised	600	530.7	550				5	—
	100-036-944	MSH-550SL		Matte Silver/Anodised						800		
	100-036-945	MSH-550BL		Matte Black/Anodised	1663	5	—					
	100-036-946	MSH-750SL		Matte Silver/Anodised						5	—	
	100-036-947	MSH-750BL		Matte Black/Anodised								

DESIGN HANDLE (STRAIGHT TYPE)

TEST METHOD 1

AGH-L/AGH-T

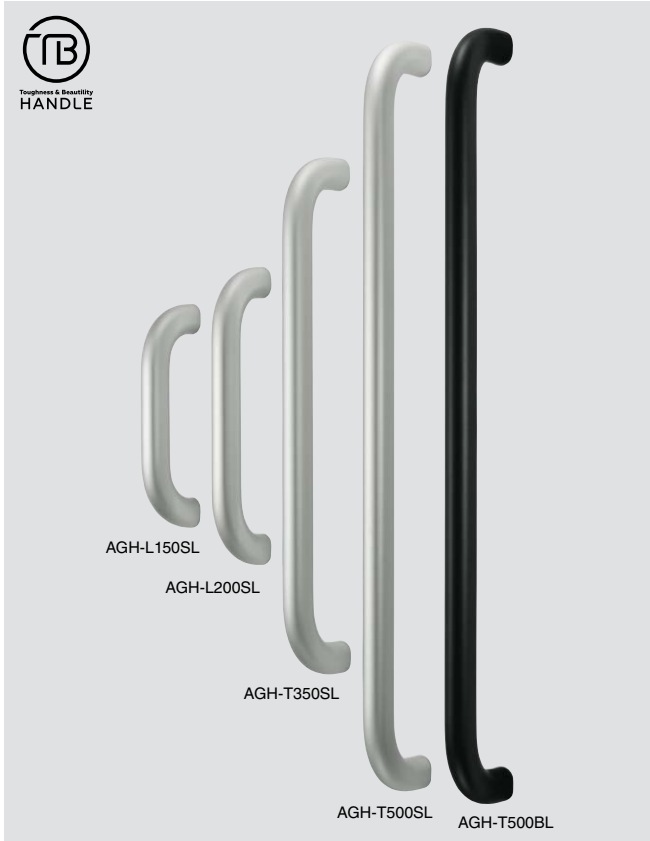

Features

- Elliptical profile combines minimalist look with maximum grip.
- Available in different heights.

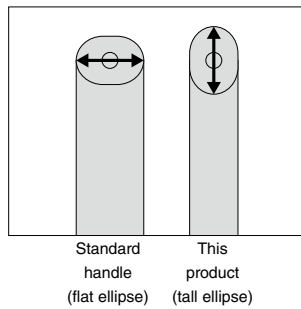
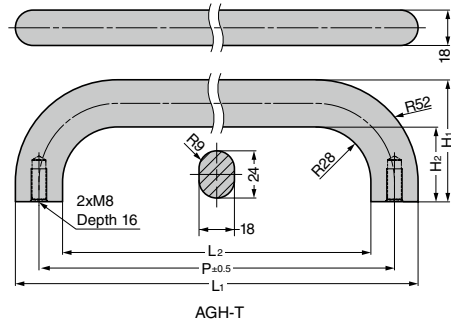
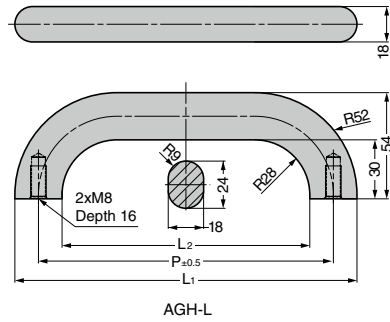

CAD	Item Code	Item Name	Material	Finish	L ₁	L ₂	P	Load Capacity N	Load Capacity kgf	Weight (g)	Box (pcs)	Carton (pcs)
2D/3D	100-036-962	AGH-L150SL	Aluminium Alloy	Matte Silver/Anodised	174	126	150	350	36	191	5	40
2D/3D	100-036-963	AGH-L150BL		Matte Black/Anodised							5	40
2D/3D	100-036-964	AGH-L200SL		Matte Silver/Anodised	224	176	200			240	5	40
2D/3D	100-036-965	AGH-L200BL		Matte Black/Anodised							5	40
2D/3D	100-036-966	AGH-L350SL		Matte Silver/Anodised	374	326	350			387	5	20
2D/3D	100-036-967	AGH-L350BL		Matte Black/Anodised							5	20
2D/3D	100-036-968	AGH-L500SL		Matte Silver/Anodised	524	476	500			536	5	20
2D/3D	100-036-969	AGH-L500BL		Matte Black/Anodised							5	20

CAD	Item Code	Item Name	Material	Finish	L ₁	L ₂	H ₁	H ₂	P	Load Capacity N	Load Capacity kgf	Weight (g)	Box (pcs)	Carton (pcs)
2D/3D	100-036-958	AGH-T350SL	Aluminium Alloy	Matte Silver/Anodised	374	326	62	38	350	350	36	402	5	20
2D/3D	100-036-959	AGH-T350BL		Matte Black/Anodised									5	20
2D/3D	100-036-960	AGH-T500SL		Matte Silver/Anodised	524	476	64	40	500			553	5	20
2D/3D	100-036-961	AGH-T500BL		Matte Black/Anodised									5	20

DESIGN HANDLE (OFFSET TYPE)

TEST METHOD 1

AGH-F

HANDLES,
PULLS & KNOBS

DESIGN HANDLE (OFFSET TYPE)



Features

Handles that are delightful to hold.

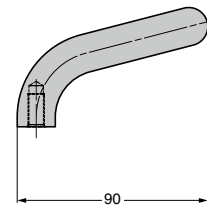
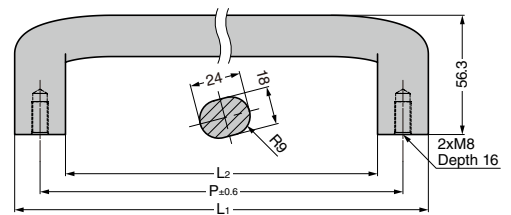

CAD	Item Code	Item Name	Material	Finish	L ₁	L ₂	P	Load Capacity N	Load Capacity kgf	Weight (g)	Box (pcs)	Carton (pcs)
	100-036-970	AGH-F300SL	Aluminium Alloy	Matte Silver/Anodised	324	276	300	500	51	443	6	24
	100-036-971	AGH-F300BL		Matte Black/Anodised							6	24
	100-036-972	AGH-F400SL		Matte Silver/Anodised	424	376	400				6	18
	100-036-973	AGH-F400BL		Matte Black/Anodised							6	18

DESIGN HANDLE

ALH

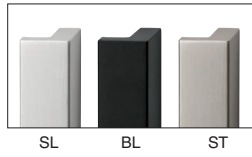
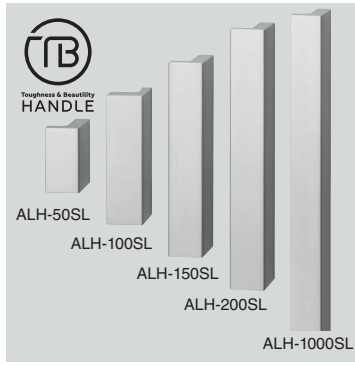

Features

- Stylish in form and function.
- Design innovations include anti-slip bump along the edges and angled surface to prevent dust accumulation.

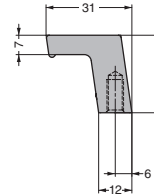
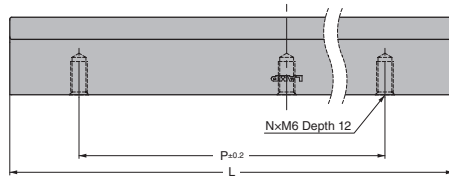

CAD	Item Code	Item Name	Material	Finish	L	P	N	Load Capacity N	Load Capacity kgf	Weight (g)	Box (pcs)	Carton (pcs)									
2030	100-037-006	ALH-50SL	Aluminium Alloy	Matte Silver Anodised	50	30	2	500	51	58	10	120									
2030	100-037-007	ALH-50BL		Matte Black Anodised							10	120									
2030	100-037-008	ALH-50ST		Satin and Stainless Steel Anodised							10	120									
2030	100-037-009	ALH-100SL		Matte Silver Anodised	100	60				2	500	51	118	10	80						
2030	100-037-010	ALH-100BL		Matte Black Anodised										10	80						
2030	100-037-011	ALH-100ST		Satin and Stainless Steel Anodised										10	80						
2030	100-037-012	ALH-150SL		Matte Silver Anodised	150	100							2	500	51	178	10	40			
2030	100-037-013	ALH-150BL		Matte Black Anodised													10	40			
2030	100-037-014	ALH-150ST		Satin and Stainless Steel Anodised	10	40															
2030	100-037-015	ALH-200SL		Matte Silver Anodised	200	75										3	500	51	237	6	36
2030	100-037-016	ALH-200BL		Matte Black Anodised																6	36
2030	100-037-017	ALH-200ST		Satin and Stainless Steel Anodised																6	36
2030	100-037-018	ALH-1000SL	Matte Silver Anodised	1000	150	7	500	51	1191										6	12	
2030	100-037-019	ALH-1000BL	Matte Black Anodised																6	12	
2030	100-037-020	ALH-1000ST	Satin and Stainless Steel Anodised																6	12	

DESIGN HANDLE



SYH



Features

- A flowing handle with a feature line down the centre.
- Aluminium material and streamline shape create a soft impression. Low profile design ensures that the handle will not noticeably protrude.
- With anti-bacterial coating to reduce risk of infection.

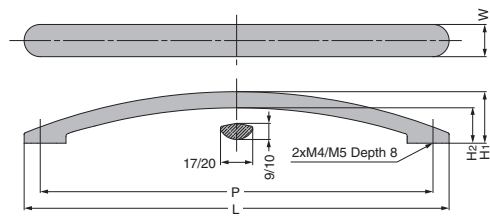

CAD	Item Code	Item Name	Material	Finish	L	P	H ₁	H ₂	W	M	Load Capacity N	Load Capacity kgf	Weight (g)	Box (pcs)	Carton (pcs)
2030	100-037-002	SYH-128SL-M4	Aluminium Alloy	Antibacterial Paint/Silver	165	128	30	21	17	M4	500	51	53	10	80
2030	100-037-003	SYH-128SL-M5								M5				10	80
2030	100-037-004	SYH-224SL-M4			264	224	32	22	20	M4			105	10	80
2030	100-037-005	SYH-224SL-M5			M5	10	80								

STAINLESS STEEL HANDLE

HGH

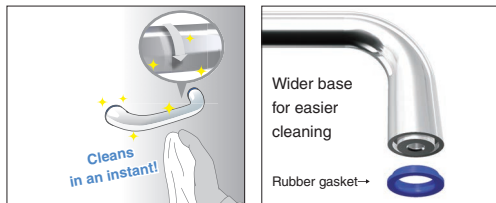

The handle shape and the mirror finish are designed to prevent dust accumulation. This helps to suppress bacterial propagation and allows for faster and easier cleaning.

The silicone rubber mount provides a snug fit between the handle and the mounting surface.

Features

- Wider base for easy cleaning.
- Silicone rubber gasket is compliant with the Food Sanitation Act.

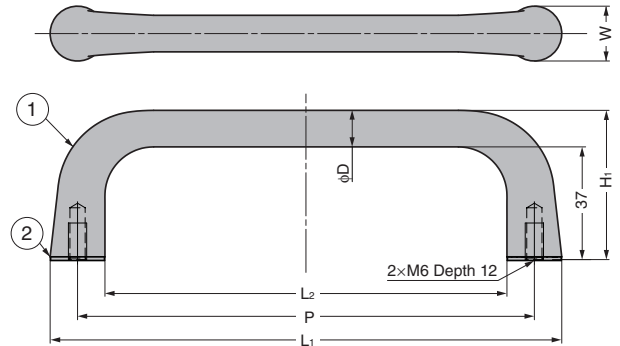

No.	Part Name	Material	Finish/Colour
①	Body	Stainless Steel (SCS13)	Mirror
②	Gasket	Silicone rubber (Q)	Blue

CAD	Item Code	Item Name	L ₁	L ₂	W	H ₁	P	D	Load Capacity N	Load Capacity kgf	Weight (g)
PC3D	100-037-021	HGH-115SM	130	100	15	47	115	10	400	40.8	144
PC3D	100-037-022	HGH-150SM	168	132	18	49	150	12	500	51	244
PC3D	100-037-023	HGH-200SM	222.5	177.5	22.5	52	200	15			463

STAINLESS STEEL HANDLE

SUS

H-35



Parts Included

Truss head screw M4x45

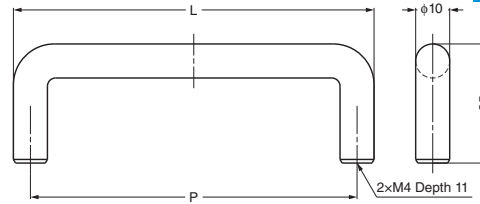

CAD	Item Code	Item Name	Material	Finish	L	P	Weight (g)	Box (pcs)	Carton (pcs)
-	100-036-723	H-35-96-SS	Stainless Steel (SUS304)	Mirror	106	96	95	25	-
-	100-036-724	H-35-96-SM		Satin	106	96	95	25	-
-	100-036-725	H-35-128-SS		Mirror	138	128	113	25	-
-	100-036-726	H-35-128-SM		Satin	138	128	113	25	-
-	100-036-727	H-35-160-SS		Mirror	170	160	133	25	-
-	100-036-728	H-35-160-SM		Satin	170	160	133	25	-
-	100-036-729	H-35-192-SS		Mirror	202	192	153	25	-
-	100-036-730	H-35-192-SM		Satin	202	192	153	25	-
-	100-036-731	H-35-288-SS		Mirror	298	288	208	25	-
-	100-036-732	H-35-288-SM		Satin	298	288	208	25	-

STAINLESS STEEL HANDLE

SUS

H-29



Parts Included

Truss head screw M4x45

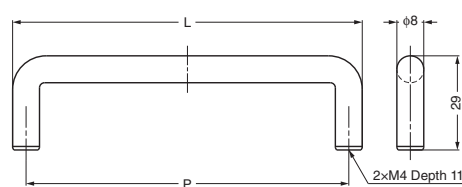

CAD	Item Code	Item Name	Material	Finish	L	P	Weight (g)	Box (pcs)	Carton (pcs)
-	100-036-733	H-29-64-SS	Stainless Steel (SUS304)	Mirror	72	64	46	25	-
-	100-036-734	H-29-64-SM		Satin	72	64	46	25	-
-	100-036-735	H-29-96-SS		Mirror	104	96	58	25	-
-	100-036-736	H-29-96-SM		Satin	104	96	58	25	-
-	100-036-737	H-29-128-SS		Mirror	136	128	71	25	-
-	100-036-738	H-29-128-SM		Satin	136	128	71	25	-
-	100-036-739	H-29-160-SS		Mirror	168	160	64	25	-
-	100-036-740	H-29-160-SM		Satin	168	160	64	25	-
-	100-036-741	H-29-192-SS		Mirror	200	192	98	25	-
-	100-036-742	H-29-192-SM		Satin	200	192	98	25	-

STAINLESS STEEL HANDLE

SUS

FT-R



Features

- A rounded handle for a comfortable grip.
- Wide grip.

Parts Included

- FT-R-120: Raised countersunk head tapping screw 4x20 (SUS)
- FT-R-160: Raised countersunk head tapping screw 5x25 (SUS)

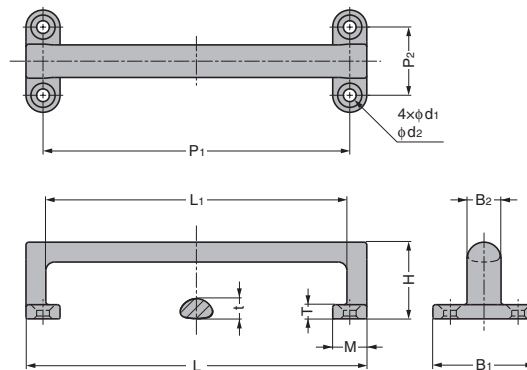

CAD	Item Code	Item Name	Material	Finish	L	L ₁	B ₁	B ₂	H	T	t	M	P ₁	P ₂	d ₁	d ₂	Weight (g)	Box (pcs)	Carton (pcs)
	100-034-130	FT-R-120	Stainless Steel	Polished	120	106	36	12	27	5.5	7	12	108	24	4.5	8.5	140	10	60
	100-034-131	FT-R-160	(SCS13)		160	142	48	16	36	7	9	16	144	32	5.5	10.5	285	5	20

*SCS13 is equivalent of SUS304.

STAINLESS STEEL HANDLE

SUS316

FT-T



Features

- A substantial and firm shape with rounded inside edges allows for easy gripping.
- Wide grip.

Parts Included

- FT-T-120: Raised countersunk head tapping screw 4x20 (SUS)
- FT-T-170: Raised countersunk head tapping screw 5x25 (SUS)
- FT-T-220: Raised countersunk head tapping screw 6x35 (SUS)

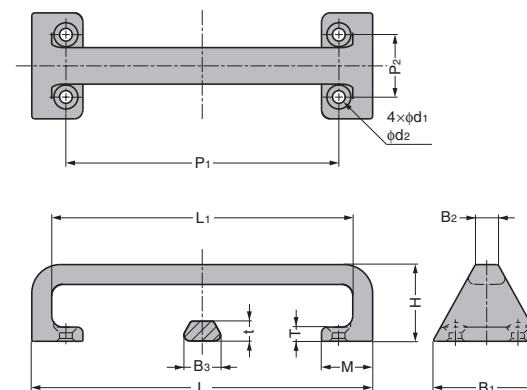

CAD	Item Code	Item Name	Material	Finish	L	L ₁	B ₁	B ₂	B ₃	H	T	t	M	P ₁	P ₂	d ₁	d ₂	Weight (g)	Box (pcs)	Carton (pcs)
	100-034-132	FT-T-120	Stainless	Polished	120	105	39.3	10	15.1	28.5	6	7	19	96	24	4.5	8.5	225	10	40
	100-034-133	FT-T-170	Steel		170	150	53.3	12	18.7	38	7.5	10	25.5	135	32	5.5	10.5	500	5	20
	100-034-134	FT-T-220	(SCS14)		220	200	69.3	15	24.3	49.5	9.5	13	32.5	176	41	6.5	12.5	1000	1	10

*SCS14 is equivalent of SUS316.

COLOURED NYLON HANDLE

CJH

HANDLES,
PULLS & KNOBS

COLOURED NYLON HANDLE

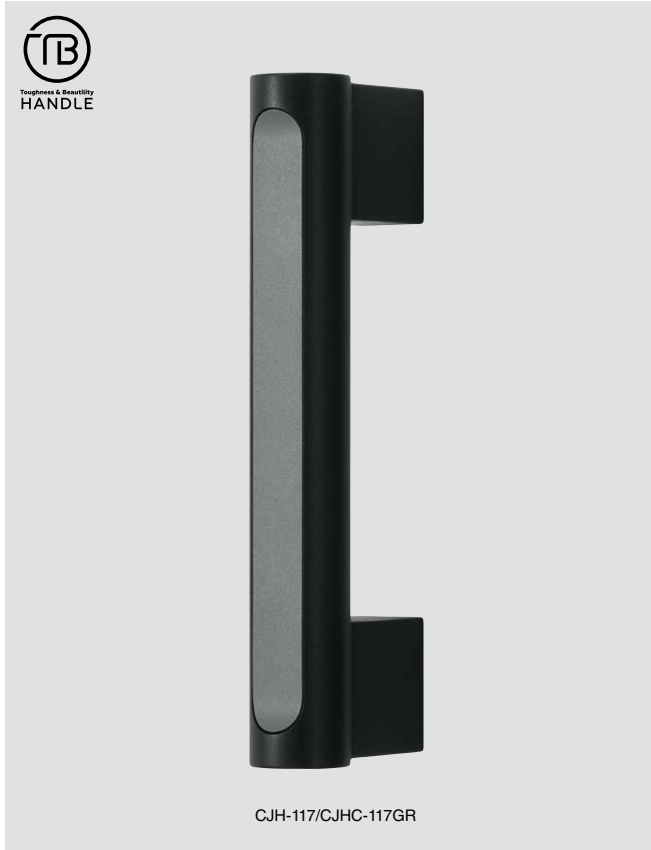

Features

- Long colour cap facilitates intuitive operation.
- The cover colours are used for indicating dangerous regions and different work areas.
- Handle can be fixed from either the front or back with screws.

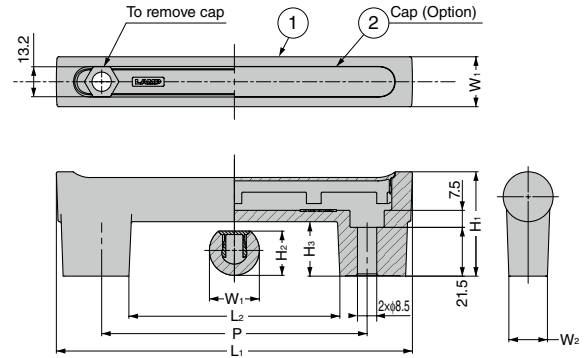

Fix from surface

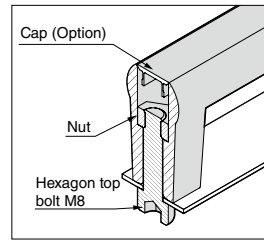

Fix from back side

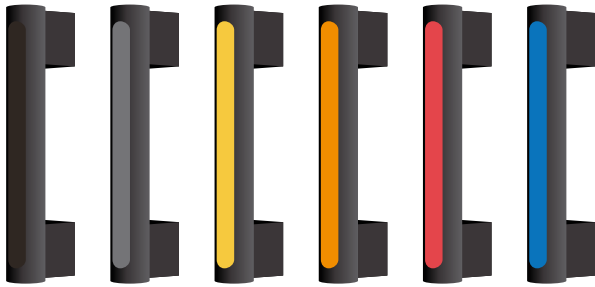
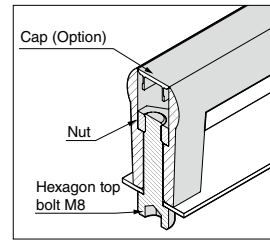

BL GR YE YR RD BU

No.	Part Name	Material
①	Body	Reinforced nylon
②	Cap	PA

Body

CAD	Item Code	Item Name	Material	L ₁	L ₂	W ₁	W ₂	H ₁	H ₂	H ₃	P	Load Capacity N	Load Capacity kgf	Weight (g)	Box (pcs)	Carton (pcs)
2030	100-036-974	CJH-117BL	Reinforced nylon	157	93	22	17	46	19.5	24	117	-	-	67	50	-
2030	100-036-975	CJH-150BL	nylon	190	125.5	24	18.5	52	21.4	28	150	-	-	91	50	-

Cap Sold Separately

CAD	Item Code	Item Name	Material	Colour	Weight (g)	Box (pcs)	Carton (pcs)
2030	100-036-976	CJHC-117BL	PA	Black	4	100	-
2030	100-036-977	CJHC-117GR		Grey		100	-
2030	100-036-978	CJHC-117YE		Yellow		100	-
2030	100-036-979	CJHC-117YR		Orange		100	-
2030	100-036-980	CJHC-117RD		Red		100	-
2030	100-036-981	CJHC-117BU		Blue		100	-
2030	100-036-982	CJHC-150BL		Black	6	100	-
2030	100-036-983	CJHC-150GR		Grey		100	-
2030	100-036-984	CJHC-150YE		Yellow		100	-
2030	100-036-985	CJHC-150YR		Orange		100	-
2030	100-036-986	CJHC-150RD		Red		100	-
2030	100-036-987	CJHC-150BU		Blue		100	-

COLOURED NYLON HANDLE

SJH



SJH-162/SJHC-162YR

Features

- A rounded handle for a comfortable grip.
- Handle can be fixed from either the front or back with screws.

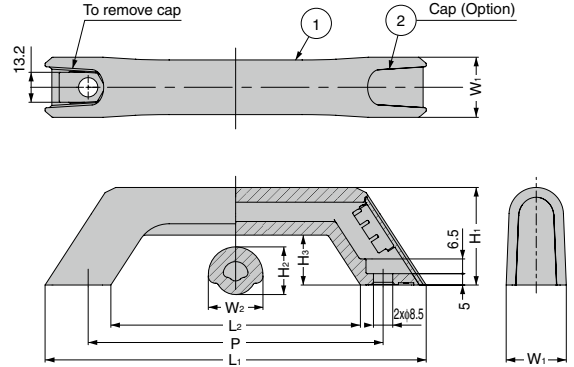

Fix from surface

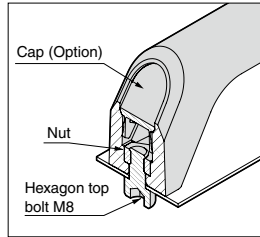

Fix from back side

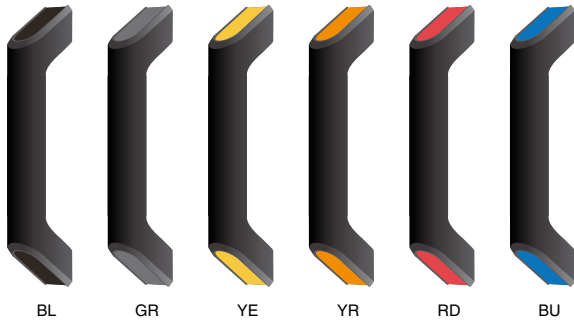
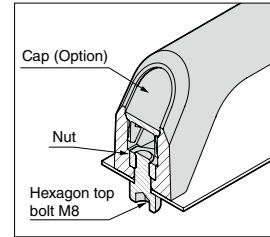

No.	Part Name	Material
①	Body	Reinforced nylon
②	Cap	PA

Body

CAD	Item Code	Item Name	Material	L ₁	L ₂	W ₁	W ₂	H ₁	H ₂	H ₃	P	Load Capacity N	Load Capacity kgf	Weight (g)	Box (pcs)	Carton (pcs)
2030	100-036-988	SJH-130	Reinforced nylon	168	110	26.5	24	43	21	22	130	-	-	76	50	-
2030	100-036-989	SJH-160		198	140	28.5	26	49	23	26	160			103	50	-

Cap Sold Separately

CAD	Item Code	Item Name	Material	Colour	Weight (g)	Box (pcs)	Carton (pcs)
2030	100-036-990	SJHC-130BL	PA	Black	1.5	100	-
2030	100-036-991	SJHC-130GR		Grey		100	-
2030	100-036-992	SJHC-130YE		Yellow		100	-
2030	100-036-993	SJHC-130YR		Orange		100	-
2030	100-036-994	SJHC-130RD		Red		100	-
2030	100-036-995	SJHC-130BU		Blue		100	-
2030	100-036-996	SJHC-160BL	PA	Black	1.9	100	-
2030	100-036-997	SJHC-160GR		Grey		100	-
2030	100-036-998	SJHC-160YE		Yellow		100	-
2030	100-036-999	SJHC-160YR		Orange		100	-
2030	100-037-000	SJHC-160RD		Red		100	-
2030	100-037-001	SJHC-160BU		Blue		100	-

RECESSED PULL

Under Development **SUS** HH-UD

HANDLES,
PULLS & KNOBS

RECESSED PULL



Features

- Grips on both sides allow the door to be moved in either direction.
- Solid grip interior with rounded edges for optimum comfort.
- SEMI-compliant large size (SEMI S8-0915) and mini size with clean appearance are available.

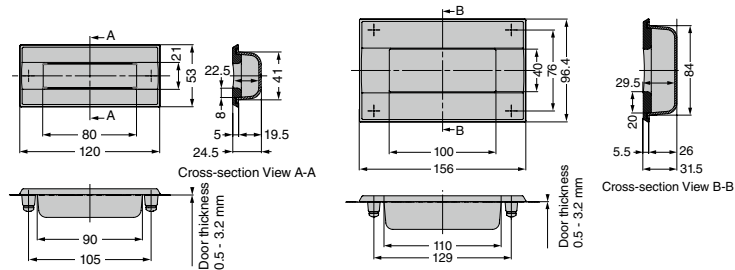
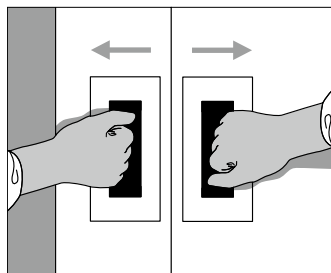

CAD	Item Code	Item Name	Material	Finish	Load Capacity N	Load Capacity kgf	Weight (g)	Box (pcs)	Carton (pcs)
	100-037-024	HH-UD120SH	Stainless steel	Satin	-	-	-	-	-
	100-037-025	HH-UD120SM		Mirror			-	-	
	100-037-026	HH-UD156SH	(SCS13)/ ABS+PC	Satin	-	-	-	-	-
	100-037-027	HH-UD156SM		Mirror			-	-	

Zwei L

Zwei L is the flagship brand of Sugatsune and represents premium Japanese hardware quality.

Zwei L stands for "Zwei Lichter" in German: a dual highlight of mirror finish and lustrous satin on a faceted profile.

Manufactured from solid billets of the finest quality 316 stainless steel, **Zwei L** brings the space luxury and dazzles your eyes.

Video Link



Zwei L®

Zwei L STAINLESS STEEL HANDLE



ZL-2001



Features

- Ultrapremium Zwei L finish. Zwei L finish: Using top class polishing technology, these products combine the elegance of Satin with the deep glow of a Mirror.
- When combined with XL-2301, can be attached to glass
- Similar chamfered handles without Zwei-L polishing: XL-CU and XL-JS

Parts Included

Truss head screw M4x30 (SUS)

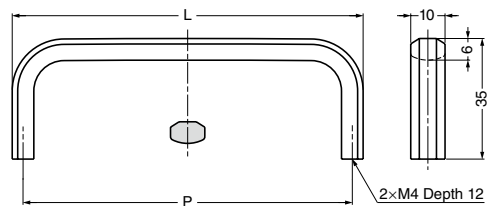

Item Code	Item Name	Material	Finish	L	P	Weight	Box
100-011-000	ZL-2001- 32	Stainless Steel (SUS316)	Zwei L Finish	38	32	49 g	20 pcs
100-011-001	ZL-2001- 64	Stainless Steel (SUS316)	Zwei L Finish	70	64	63 g	12 pcs
100-011-002	ZL-2001- 96	Stainless Steel (SUS316)	Zwei L Finish	102	96	75 g	12 pcs
100-011-003	ZL-2001-128	Stainless Steel (SUS316)	Zwei L Finish	134	128	89 g	10 pcs
100-011-037	ZL-2001-160	Stainless Steel (SUS316)	Zwei L Finish	166	160	108 g	10 pcs
100-011-038	ZL-2001-192	Stainless Steel (SUS316)	Zwei L Finish	198	192	130 g	6 pcs
100-011-039	ZL-2001-256	Stainless Steel (SUS316)	Zwei L Finish	262	256	164 g	6 pcs

Zwei L STAINLESS STEEL HANDLE



ZL-2002



Features

- Ultrapremium Zwei L finish. Zwei L finish: Using top class polishing technology, these products combine the elegance of Satin with the deep glow of a Mirror.
- When combined with XL-2301, can be attached to glass

Parts Included

Truss head screw M5×30 (SUS)

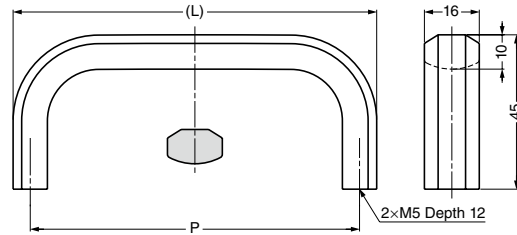

Item Code	Item Name	Material	Finish	L	P	Weight	Box
100-011-004	ZL-2002- 96	Stainless Steel (SUS316)	Zwei L Finish	106	96	165 g	12 pcs
100-011-005	ZL-2002-128	Stainless Steel (SUS316)	Zwei L Finish	138	128	232 g	12 pcs
100-011-006	ZL-2002-160	Stainless Steel (SUS316)	Zwei L Finish	170	160	242 g	12 pcs
100-011-007	ZL-2002-192	Stainless Steel (SUS316)	Zwei L Finish	202	192	305 g	6 pcs
100-011-008	ZL-2002-256	Stainless Steel (SUS316)	Zwei L Finish	266	256	353 g	6 pcs
100-011-009	ZL-2002-320	Stainless Steel (SUS316)	Zwei L Finish	330	320	482 g	6 pcs
100-014-431	ZL-2002-416	Stainless Steel (SUS316)	Zwei L Finish	426	416	491 g	4 pcs
100-014-432	ZL-2002-512	Stainless Steel (SUS316)	Zwei L Finish	522	512	587 g	4 pcs

Zwei L BRACKET FOR STAINLESS STEEL HANDLE



ZL-2301



Features

- Zwei L series bracket for ZL-2001, ZL-2002, ZL-2003 and ZL-2004 handles to attach to glass.
- Ultrapremium Zwei L finish. Zwei L finish: Using top class polishing technology, these products combine the elegance of Satin with the deep glow of a Mirror.
- Applicable glass thicknesses: 4, 5 and 6mm

Bracket Set for ZL-2001φ16 (w/Screw)

Item Code	Item Name
100-010-978	ZL-2301-2016

No.	Part Name	Material	Finish/Colour	Box
①	Bracket (φ16)	Stainless Steel (SUS316)	Zwei L Finish	2 pcs
③	Gasket (φ14)	Elastomer (TPE)	Clear	4 pcs
⑤	Truss Head Screw M4×16	Stainless Steel	Zwei L Finish	2 pcs

Bracket Set for ZL-2002φ25 (w/Screw)

Item Code	Item Name
100-010-979	ZL-2301-2025

No.	Part Name	Material	Finish/Colour	Box
②	Bracket (φ25)	Stainless Steel (SUS316)	Zwei L Finish	2 pcs
③	Gasket (φ14)	Elastomer (TPE)	Clear	2 pcs
④	Gasket (φ20)	Elastomer (TPE)	Clear	2 pcs
⑥	Truss Head Screw M5×16	Stainless Steel	Zwei L Finish	2 pcs

① Bracket (φ16)

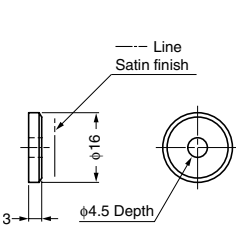

② Bracket (φ25)

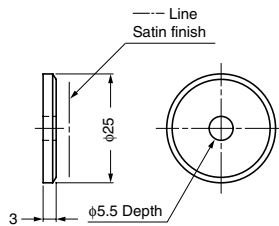

③ Gasket (φ14)
④ Gasket (φ20)

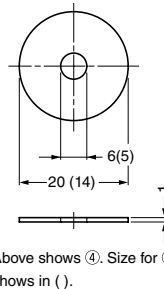

⑤ Truss head screw M4×16

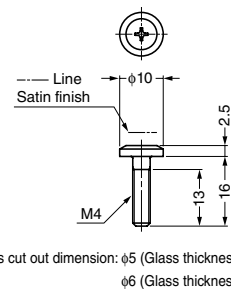

⑥ Truss head screw M5×16

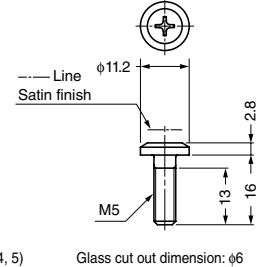

STAINLESS STEEL HANDLE



EK-S

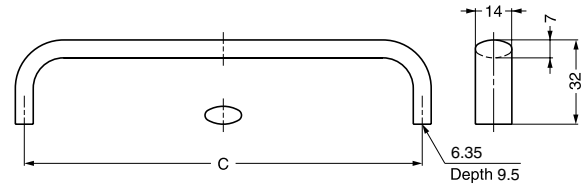

Item Code	Item Name	C	Weight	Box	Carton
100-023-426	100-023-430 EK-S635/M EK-S635/S	88.9	106 g	20 pcs	200 pcs
100-023-427	100-023-431 EK-S640/M EK-S640/S	101.6	116 g		
100-023-428	100-023-432 EK-S650/M EK-S650/S	127	134 g		
100-023-429	100-023-433 EK-S660/M EK-S660/S	152.4	152 g		

Material	Finish
316 Stainless Steel	Mirror (M) Satin (S)

STAINLESS STEEL HANDLE



KC-S

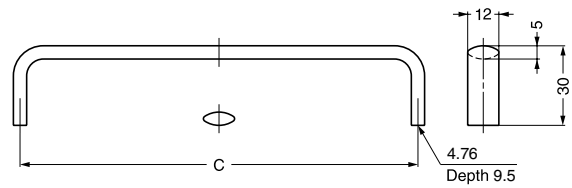
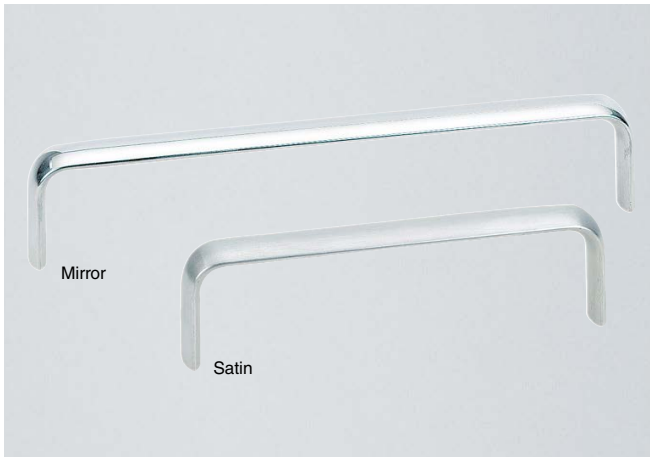

Item Code	Item Name	C	Weight	Box	Carton
100-023-410	100-023-414 KC-S635/M KC-S635/S	88.9	67 g	20 pcs	200 pcs
100-023-411	100-023-415 KC-S640/M KC-S640/S	101.6	71 g		
100-023-412	100-023-416 KC-S650/M KC-S650/S	127	85 g		
100-023-413	100-023-417 KC-S660/M KC-S660/S	152.4	95 g		

Material	Finish
316 Stainless Steel	Mirror (M) Satin (S)

STAINLESS STEEL HANDLE



KC-R

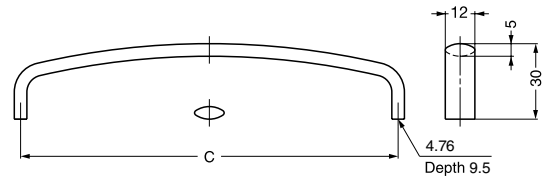

HANDLES,
PULLS & KNOBS

Item Code	Item Name	C	Weight	Box	Carton
100-023-418	100-023-422 KC-R635/M KC-R635/S	88.9	60 g	20 pcs	200 pcs
100-023-419	100-023-423 KC-R640/M KC-R640/S	101.6	67 g		
100-023-420	100-023-424 KC-R650/M KC-R650/S	127	78 g		
100-023-421	100-023-425 KC-R660/M KC-R660/S	152.4	88 g		

Material	Finish
316 Stainless Steel	Mirror (M) Satin (S)

STAINLESS STEEL HANDLE



XL-JS



Features

Exquisite combination of satin and mirror finishes

Parts Included

Truss head screw M4x25 (SUS)

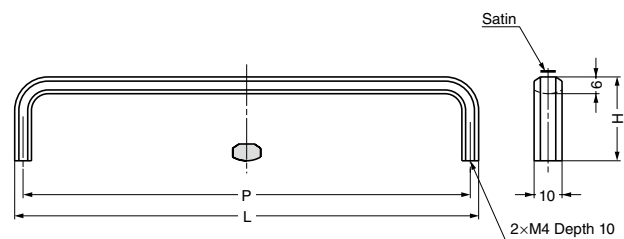

STAINLESS STEEL HANDLE

Item Code	Item Name	Material	Finish	L	P	H	Weight	Box	Carton
100-012-792	XL-JS165TT	Stainless Steel (SUS316)	Mirror and Satin Combination	166	160	30	87 g	15 pcs	150 pcs
100-012-793	XL-JS260TT	Stainless Steel (SUS316)	Mirror and Satin Combination	260	254	33	130 g	10 pcs	100 pcs
100-012-794	XL-JS360TT	Stainless Steel (SUS316)	Mirror and Satin Combination	358	352	36	173 g	10 pcs	100 pcs

STAINLESS STEEL HANDLE



XL-JSR

HANDLES,
PULLS & KNOBS



Features

Exquisite combination of satin and mirror finishes

Parts Included

Truss head screw M4x25 (SUS)

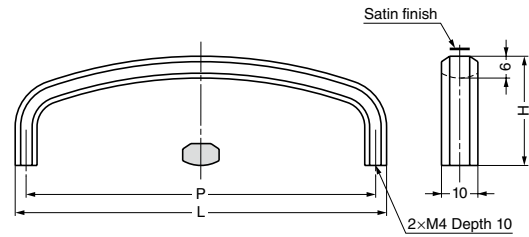

Item Code	Item Name	Material	Finish	L	P	H	Weight	Box	Carton
100-012-795	XL-JSR 40TT	Stainless Steel (SUS316)	Mirror and Satin Combination	38	32	27	33 g	30 pcs	300 pcs
100-012-796	XL-JSR 70TT	Stainless Steel (SUS316)	Mirror and Satin Combination	70	64	30	45 g	20 pcs	200 pcs
100-012-797	XL-JSR100TT	Stainless Steel (SUS316)	Mirror and Satin Combination	102	96	30	57 g	20 pcs	200 pcs
100-012-798	XL-JSR135TT	Stainless Steel (SUS316)	Mirror and Satin Combination	134	128	30	69 g	15 pcs	150 pcs

STAINLESS STEEL HANDLE



EK-R

STAINLESS STEEL HANDLE



Parts Included

Uses top quality, highly corrosion resistant SUS316

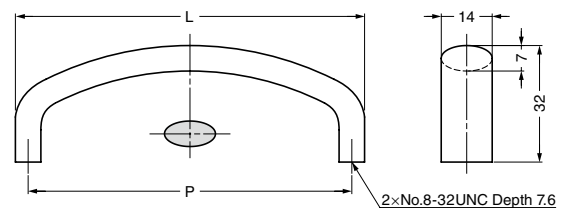

Item Code	Item Name	Material	Finish	L	P	Weight	Box	Carton
100-010-460	EK-R635/M	Stainless Steel (SUS316)	Mirror	95.9	88.9	95 g	20 pcs	200 pcs
100-010-464	EK-R635/S	Stainless Steel (SUS316)	Satin	95.9	88.9	95 g	20 pcs	200 pcs
100-010-461	EK-R640/M	Stainless Steel (SUS316)	Mirror	108.6	101.6	106 g	20 pcs	200 pcs
100-010-465	EK-R640/S	Stainless Steel (SUS316)	Satin	108.6	101.6	106 g	20 pcs	200 pcs
100-010-462	EK-R650/M	Stainless Steel (SUS316)	Mirror	134	127	123 g	20 pcs	200 pcs
100-010-466	EK-R650/S	Stainless Steel (SUS316)	Satin	134	127	123 g	20 pcs	200 pcs
100-010-463	EK-R660/M	Stainless Steel (SUS316)	Mirror	159.4	152.4	141 g	20 pcs	200 pcs
100-010-467	EK-R660/S	Stainless Steel (SUS316)	Satin	159.4	152.4	141 g	20 pcs	200 pcs

STAINLESS STEEL HANDLE



LX



Parts Included

Truss head screw M4x25 (SUS)

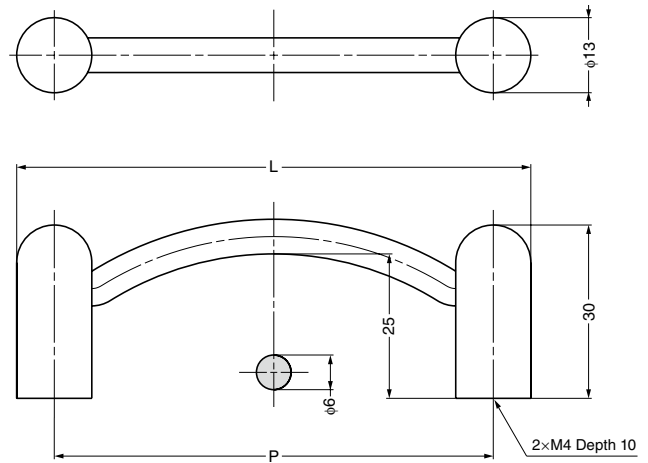

Item Code	Item Name	Material	Finish	L	P	Weight	Box	Carton
100-010-425	LX- 90M	Stainless Steel (SUS304)	Mirror	89	76	75 g	10 pcs	160 pcs
100-010-426	LX-110M	Stainless Steel (SUS304)	Mirror	109	96	80 g	10 pcs	160 pcs

STAINLESS STEEL HANDLE



XL-CU



Features

Exquisite combination of satin and mirror finishes

Parts Included

Truss head screw M5x30 (SUS)

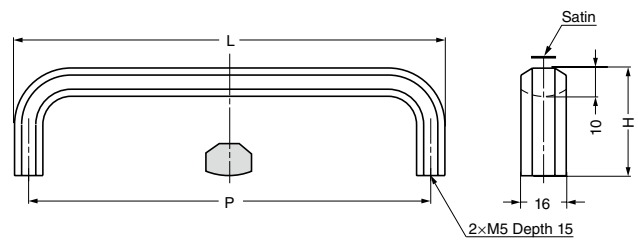

Item Code	Item Name	Material	Finish	L	H	P	Weight	Box	Carton
100-010-470	XL-CU 80TT	Stainless Steel (SUS303)	Mirror and Satin Combination	82	32	72	125 g	10 pcs	100 pcs
100-010-471	XL-CU100TT	Stainless Steel (SUS303)	Mirror and Satin Combination	102	34	92	151 g	10 pcs	100 pcs
100-010-472	XL-CU120TT	Stainless Steel (SUS303)	Mirror and Satin Combination	122	36	112	178 g	10 pcs	100 pcs
100-010-473	XL-CU150TT	Stainless Steel (SUS303)	Mirror and Satin Combination	152	38	142	215 g	8 pcs	80 pcs
100-010-474	XL-CU180TT	Stainless Steel (SUS303)	Mirror and Satin Combination	182	40	172	286 g	8 pcs	80 pcs
100-010-475	XL-CU220TT	Stainless Steel (SUS303)	Mirror and Satin Combination	222	42	212	309 g	8 pcs	40 pcs
100-010-476	XL-CU300TT	Stainless Steel (SUS303)	Mirror and Satin Combination	302	44	292	392 g	6 pcs	30 pcs

HANDLES,
PULLS & KNOBS

STAINLESS STEEL HANDLE

STAINLESS STEEL HANDLE



XL-CUR



Features

Exquisite combination of satin and mirror finishes

Parts Included

Truss head screw M5×25

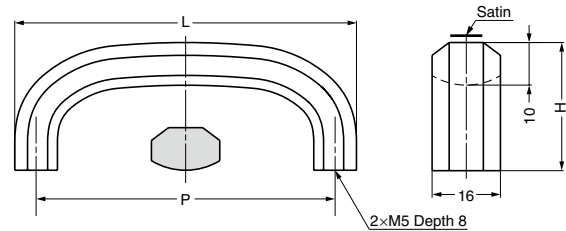

Item Code	Item Name	Material	Finish	L	H	P	Weight	Box	Carton
100-012-825	XL-CUR 80TT	Stainless Steel (SUS303)	Mirror and Satin Combination	80	30	70	115 g	10 pcs	150 pcs
100-012-826	XL-CUR100TT	Stainless Steel (SUS303)	Mirror and Satin Combination	100	32	90	137 g	10 pcs	150 pcs
100-012-827	XL-CUR120TT	Stainless Steel (SUS303)	Mirror and Satin Combination	120	34	110	160 g	10 pcs	100 pcs
100-012-828	XL-CUR150TT	Stainless Steel (SUS303)	Mirror and Satin Combination	150	36	140	196 g	5 pcs	75 pcs

STAINLESS STEEL HANDLE



DL-SUS304



Parts Included

Truss head screw M4×28 (SUS)

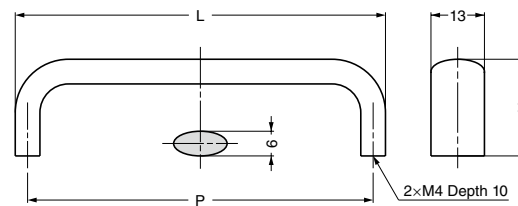

Item Code	Item Name	Material	Finish	L	H	P	Weight	Box	Carton
100-904-563	DL- 70S-SUS304	Stainless Steel (SUS304)	Satin	70	23	64	51 g	20 pcs	200 pcs
100-904-562	DL- 70M-SUS304	Stainless Steel (SUS304)	Mirror	70	23	64	51 g	20 pcs	200 pcs
100-904-565	DL- 90S-SUS304	Stainless Steel (SUS304)	Satin	90	23.5	84	61 g	20 pcs	200 pcs
100-904-564	DL- 90M-SUS304	Stainless Steel (SUS304)	Mirror	90	23.5	84	61 g	20 pcs	200 pcs
100-904-567	DL-110S-SUS304	Stainless Steel (SUS304)	Satin	110	24	104	73 g	15 pcs	150 pcs
100-904-566	DL-110M-SUS304	Stainless Steel (SUS304)	Mirror	110	24	104	73 g	15 pcs	150 pcs
100-904-569	DL-130S-SUS304	Stainless Steel (SUS304)	Satin	130	24.5	124	83 g	15 pcs	150 pcs
100-904-568	DL-130M-SUS304	Stainless Steel (SUS304)	Mirror	130	24.5	124	83 g	15 pcs	150 pcs
100-904-571	DL-150S-SUS304	Stainless Steel (SUS304)	Satin	150	25	144	93 g	15 pcs	150 pcs
100-904-570	DL-150M-SUS304	Stainless Steel (SUS304)	Mirror	150	25	144	93 g	15 pcs	150 pcs

STAINLESS STEEL HANDLE



KB-SUS304



Parts Included

Truss head screw M3x28 (SUS)

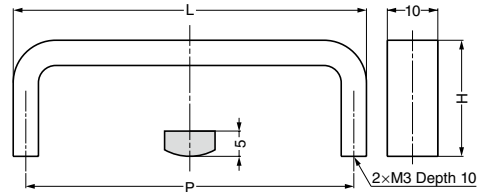

KB-50, KB-70, KB-90

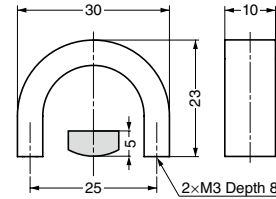

KB-30

Item Code	Item Name	Material	Finish	L	H	P	Weight	Box	Carton
100-904-581	KB-30S-SUS304	Stainless Steel (SUS304)	Satin	As Above			22 g	40 pcs	400 pcs
100-904-580	KB-30M-SUS304	Stainless Steel (SUS304)	Mirror	As Above			22 g	40 pcs	400 pcs
100-904-583	KB-50S-SUS304	Stainless Steel (SUS304)	Satin	50	22	45	29 g	30 pcs	300 pcs
100-904-582	KB-50M-SUS304	Stainless Steel (SUS304)	Mirror	50	22	45	29 g	30 pcs	300 pcs
100-904-585	KB-70S-SUS304	Stainless Steel (SUS304)	Satin	70	22.5	65	35 g	30 pcs	300 pcs
100-904-584	KB-70M-SUS304	Stainless Steel (SUS304)	Mirror	70	22.5	65	35 g	30 pcs	300 pcs
100-904-587	KB-90S-SUS304	Stainless Steel (SUS304)	Satin	90	23	85	44 g	20 pcs	200 pcs
100-904-586	KB-90M-SUS304	Stainless Steel (SUS304)	Mirror	90	23	85	44 g	20 pcs	200 pcs

STAINLESS STEEL HANDLE



DS-SUS304



Parts Included

Truss head screw M3x28 (SUS)

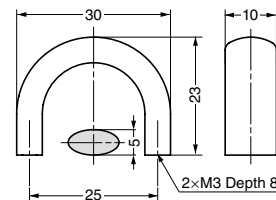

DS-30

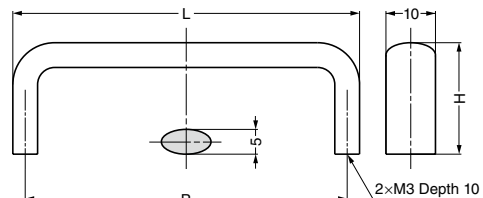

DS-50, DS-70, DS-90

Item Code	Item Name	Material	Finish	L	H	P	Weight	Box	Carton
100-904-573	DS-30S-SUS304	Stainless Steel (SUS304)	Satin	As Above			19 g	40 pcs	400 pcs
100-904-572	DS-30M-SUS304	Stainless Steel (SUS304)	Mirror	As Above			19 g	40 pcs	400 pcs
100-904-575	DS-50S-SUS304	Stainless Steel (SUS304)	Satin	50	22	45	26 g	30 pcs	300 pcs
100-904-574	DS-50M-SUS304	Stainless Steel (SUS304)	Mirror	50	22	45	26 g	30 pcs	300 pcs
100-904-577	DS-70S-SUS304	Stainless Steel (SUS304)	Satin	70	22.5	65	32 g	30 pcs	300 pcs
100-904-576	DS-70M-SUS304	Stainless Steel (SUS304)	Mirror	70	22.5	65	32 g	30 pcs	300 pcs
100-904-579	DS-90S-SUS304	Stainless Steel (SUS304)	Satin	90	23	85	37 g	20 pcs	200 pcs
100-904-578	DS-90M-SUS304	Stainless Steel (SUS304)	Mirror	90	23	85	37 g	20 pcs	200 pcs

HANDLES,
PULLS & KNOBS

STAINLESS STEEL HANDLE

STAINLESS STEEL HANDLE



DL



Parts Included
Truss head screw M4x28

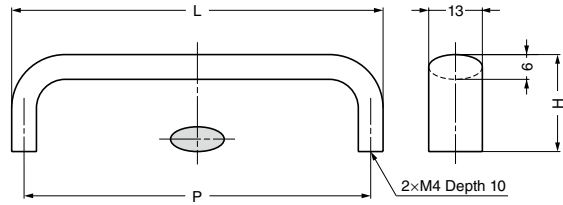

Item Code	Item Name	Material	Finish	L	H	P	Weight	Box	Carton
100-011-102	DL- 70S	Stainless Steel (SUS303)	Satin	70	23	64	50 g	20 pcs	200 pcs
100-011-101	DL- 70M	Stainless Steel (SUS303)	Mirror	70	23	64	50 g	20 pcs	200 pcs
100-011-104	DL- 90S	Stainless Steel (SUS303)	Satin	90	23.5	84	60 g	20 pcs	200 pcs
100-011-103	DL- 90M	Stainless Steel (SUS303)	Mirror	90	23.5	84	60 g	20 pcs	200 pcs
100-011-106	DL-110S	Stainless Steel (SUS303)	Satin	110	24	104	70 g	15 pcs	150 pcs
100-011-105	DL-110M	Stainless Steel (SUS303)	Mirror	110	24	104	70 g	15 pcs	150 pcs
100-011-108	DL-130S	Stainless Steel (SUS303)	Satin	130	24.5	124	80 g	15 pcs	150 pcs
100-011-107	DL-130M	Stainless Steel (SUS303)	Mirror	130	24.5	124	80 g	15 pcs	150 pcs
100-011-110	DL-150S	Stainless Steel (SUS303)	Satin	150	25	144	95 g	15 pcs	150 pcs
100-011-109	DL-150M	Stainless Steel (SUS303)	Mirror	150	25	144	95 g	15 pcs	150 pcs

STAINLESS STEEL HANDLE



DS



Parts Included
Truss head screw M3x28

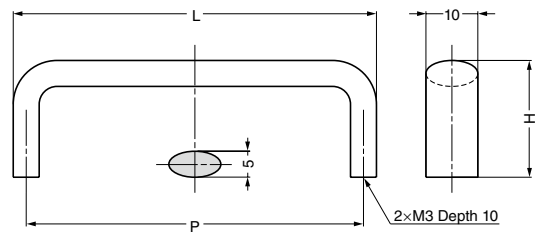

DS-50, DS-70, DS-90

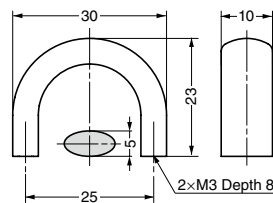

DS-30

Item Code	Item Name	Material	Finish	L	H	P	Weight	Box	Carton
100-011-112	DS-30S	Stainless Steel (SUS303)	Satin	50	22	45	20 g	40 pcs	400 pcs
100-011-111	DS-30M	Stainless Steel (SUS303)	Mirror				20 g	40 pcs	400 pcs
100-011-114	DS-50S	Stainless Steel (SUS303)	Satin	50	22	45	25 g	30 pcs	300 pcs
100-011-113	DS-50M	Stainless Steel (SUS303)	Mirror				25 g	30 pcs	300 pcs
100-011-116	DS-70S	Stainless Steel (SUS303)	Satin	70	22.5	65	32 g	30 pcs	300 pcs
100-011-115	DS-70M	Stainless Steel (SUS303)	Mirror				32 g	30 pcs	300 pcs
100-011-118	DS-90S	Stainless Steel (SUS303)	Satin	90	23	85	39 g	20 pcs	200 pcs
100-011-117	DS-90M	Stainless Steel (SUS303)	Mirror				39 g	20 pcs	200 pcs

STAINLESS STEEL HANDLE



KB



Parts Included

Truss head screw M3x28

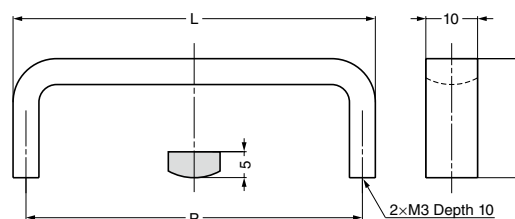

KB-50, KB-70, KB-90

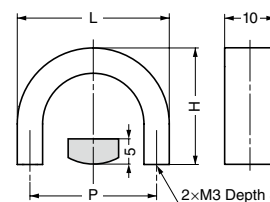

KB-30

Item Code	Item Name	Material	Finish	L	H	P	Weight	Box	Carton
100-011-094	KB-30S	Stainless Steel (SUS303)	Satin	30	23	25	22 g	40 pcs	400 pcs
100-011-093	KB-30M	Stainless Steel (SUS303)	Mirror	30	23	25	22 g	40 pcs	400 pcs
100-011-096	KB-50S	Stainless Steel (SUS303)	Satin	50	22	45	30 g	30 pcs	300 pcs
100-011-095	KB-50M	Stainless Steel (SUS303)	Mirror	50	22	45	30 g	30 pcs	300 pcs
100-011-098	KB-70S	Stainless Steel (SUS303)	Satin	70	22.5	65	37 g	30 pcs	300 pcs
100-011-097	KB-70M	Stainless Steel (SUS303)	Mirror	70	22.5	65	37 g	30 pcs	300 pcs
100-011-100	KB-90S	Stainless Steel (SUS303)	Satin	90	23	85	48 g	20 pcs	200 pcs
100-011-099	KB-90M	Stainless Steel (SUS303)	Mirror	90	23	85	48 g	20 pcs	200 pcs

STAINLESS STEEL HANDLE



EC



Parts Included

Truss head screw M5x28

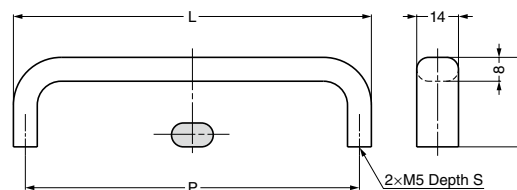

Item Code	Item Name	Material	Finish	L	H	P	S	Weight	Box	Carton
100-017-232	EC- 80S	Stainless Steel (SUS304)	Satin	80	30	72	10	94 g	20 pcs	200 pcs
100-017-226	EC- 80M	Stainless Steel (SUS304)	Mirror	80	30	72	10	94 g	20 pcs	200 pcs
100-017-233	EC-100S	Stainless Steel (SUS304)	Satin	100	32	92	10	115 g	15 pcs	150 pcs
100-017-227	EC-100M	Stainless Steel (SUS304)	Mirror	100	32	92	10	115 g	15 pcs	150 pcs
100-017-234	EC-120S	Stainless Steel (SUS304)	Satin	120	34	112	12	130 g	15 pcs	150 pcs
100-017-228	EC-120M	Stainless Steel (SUS304)	Mirror	120	34	112	12	130 g	15 pcs	150 pcs
100-017-235	EC-150S	Stainless Steel (SUS304)	Satin	150	36	142	12	157 g	10 pcs	100 pcs
100-017-229	EC-150M	Stainless Steel (SUS304)	Mirror	150	36	142	12	157 g	10 pcs	100 pcs
100-017-236	EC-180S	Stainless Steel (SUS304)	Satin	180	37	172	12	183 g	10 pcs	100 pcs
100-010-049	EC-180M	Stainless Steel (SUS304)	Mirror	180	37	172	12	183 g	10 pcs	100 pcs
100-017-237	EC-220S	Stainless Steel (SUS304)	Satin	220	38	212	12	216 g	8 pcs	80 pcs
100-010-050	EC-220M	Stainless Steel (SUS304)	Mirror	220	38	212	12	216 g	8 pcs	80 pcs

STAINLESS STEEL HANDLE



ECH
**HANDLES,
PULLS & KNOBS**

Satin finish

Mirror finish

Parts Included

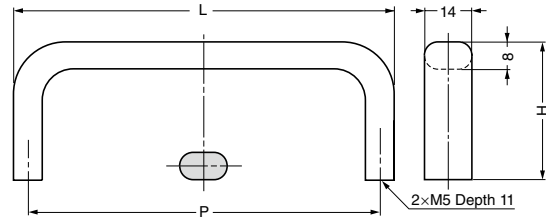
Truss head screw M5x28



Item Code	Item Name	Material	Finish	L	H	P	Weight	Box	Carton
100-017-249	ECH- 75S	Stainless Steel (SUS303)	Satin	83	40	75	110 g	10 pcs	100 pcs
100-017-241	ECH- 75M	Stainless Steel (SUS303)	Mirror	83	40	75	110 g	10 pcs	100 pcs
100-017-252	ECH-100S	Stainless Steel (SUS303)	Satin	108	40	100	135 g	15 pcs	150 pcs
100-017-242	ECH-100M	Stainless Steel (SUS303)	Mirror	108	40	100	135 g	15 pcs	150 pcs
100-017-251	ECH-125S	Stainless Steel (SUS303)	Satin	133	40	125	153 g	10 pcs	100 pcs
100-017-243	ECH-125M	Stainless Steel (SUS303)	Mirror	133	40	125	153 g	10 pcs	100 pcs
100-017-244	ECH-150M	Stainless Steel (SUS303)	Mirror	158	50	150	190 g	7 pcs	70 pcs
100-017-245	ECH-200M	Stainless Steel (SUS303)	Mirror	208	50	200	244 g	10 pcs	100 pcs
100-017-246	ECH-250M	Stainless Steel (SUS303)	Mirror	258	50	250	280 g	5 pcs	50 pcs
100-017-247	ECH-300M	Stainless Steel (SUS303)	Mirror	308	50	300	306 g	5 pcs	50 pcs

STAINLESS STEEL HANDLE

FB
STAINLESS STEEL HANDLE

Parts Included

Pan-head screw M5x25

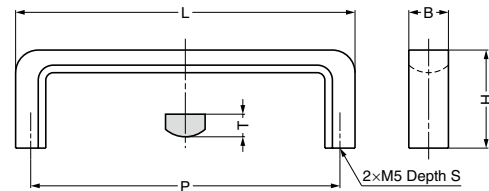

Item Code	Item Name	Material	Finish	L	H	B	T	P	S	Weight	Box	Carton
100-010-074	FB- 90	Stainless Steel (SCS13)	Mirror	90	26	10.5	6	82	10	45 g	35 pcs	280 pcs
100-010-075	FB-110	Stainless Steel (SCS13)	Mirror	110	28	12.5	7	102	12	100 g	25 pcs	200 pcs
100-010-076	FB-130	Stainless Steel (SCS13)	Mirror	130	32	14.5	8	120	14	110 g	20 pcs	160 pcs

*SCS13 is equivalent of SUS304.

STAINLESS STEEL HANDLE



H-42-C



Features

H-42-C-2, H-42-C-4, H-42-C-15 are also available in the same size in Titanium.
(H-42-C-2 has slightly different L and B sizes)

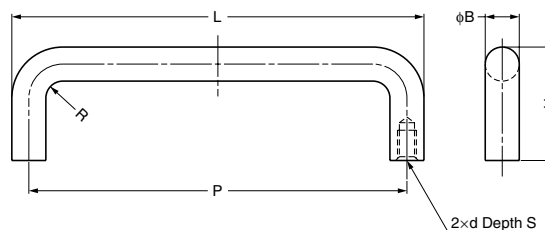

Item Code	Item Name	Material	Finish	L	H	B	P	R	d	S	Weight	Box	Carton
100-010-560	H-42-C- 8	Stainless Steel (SUS304)	Mirror	66	22	6	60	3	M4	7	18 g	100 pcs	500 pcs
100-010-562	H-42-C-14	Stainless Steel (SUS304)	Mirror	86	30	6	80	3	M4	7	25 g	50 pcs	250 pcs
100-010-561	H-42-C- 1	Stainless Steel (SUS304)	Mirror	75	30	7	68	3.5	M5	8	30 g	50 pcs	250 pcs
100-010-563	H-42-C- 2	Stainless Steel (SUS304)	Mirror	109	30	9	100	4.5	M5	8	65 g	50 pcs	150 pcs
100-010-564	H-42-C- 3	Stainless Steel (SUS304)	Mirror	120	40	10	110	5	M6	8	100 g	50 pcs	150 pcs
100-010-565	H-42-C- 4	Stainless Steel (SUS304)	Mirror	130	40	10	120	5	M6	8	105 g	50 pcs	150 pcs
100-010-566	H-42-C-15	Stainless Steel (SUS304)	Mirror	162	50	12	150	6	M8	10	185 g	30 pcs	60 pcs
100-010-567	H-42-C- 5	Stainless Steel (SUS304)	Mirror	200	50	12	188	6	M8	10	220 g	30 pcs	60 pcs
100-010-568	H-42-C- 6	Stainless Steel (SUS304)	Mirror	250	50	12	238	6	M8	10	265 g	20 pcs	40 pcs
100-010-569	H-42-C- 7	Stainless Steel (SUS304)	Mirror	300	50	12	288	6	M8	10	300 g	20 pcs	40 pcs

HANDLE



T-100-8



Features

Handle's design is tall, makes it easy to grip even when wearing gloves.

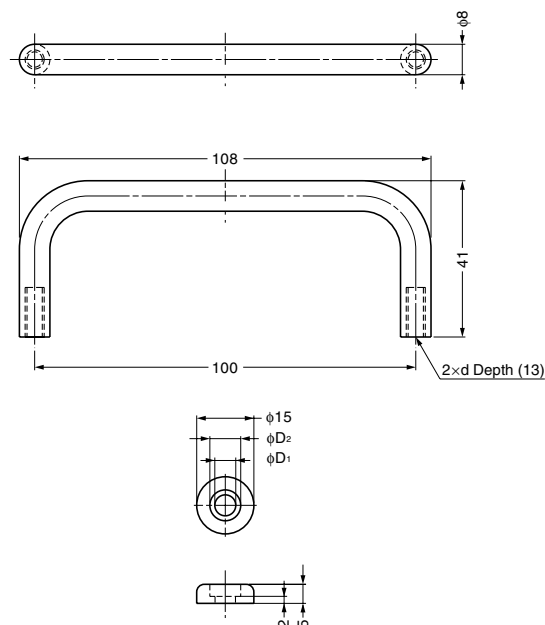

Item Code	Item Name	Material	Finish	d	D ₁	D ₂	Weight	Box	Carton
100-010-224	T-100-8S	Stainless Steel (SUS304)	Mirror	M5	5.5	8.2	72 g	10 pcs	300 pcs
100-019-855	T-100-8CR	Brass	Chrome	M4	4.5	8	78 g	50 pcs	-



HANDLES, PULLS & KNOBS
STAINLESS STEEL HANDLE / HANDLE

STAINLESS STEEL HANDLE



LF-12



Features

Grip portion has inclination, making it very easy to grab the handle.

Parts Included

Truss head screw M5x30

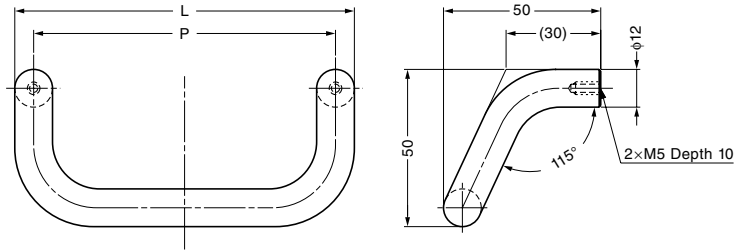

Item Code	Item Name	Material	Finish	L	P	Weight	Box
100-010-520	LF-12- 96	Stainless Steel (SUS304)	Satin	108	96	182 g	10 pcs
100-010-521	LF-12-128	Stainless Steel (SUS304)	Satin	140	128	211 g	10 pcs
100-010-522	LF-12-160	Stainless Steel (SUS304)	Satin	172	160	236 g	10 pcs

STAINLESS STEEL HANDLE



H-75-C



Features

Grip portion has inclination, making it very easy to grab the handle.

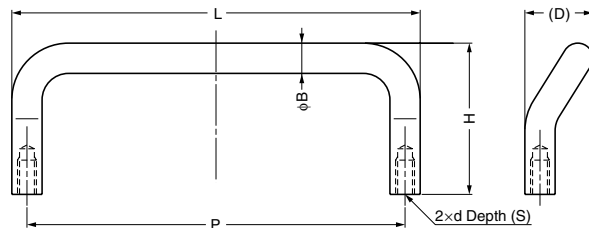

Item Code	Item Name	Material	Finish	L	H	D	B	P	d	S	Weight	Box	Carton
100-010-605	H-75-C- 66	Stainless Steel (SUS304)	Polished	66	30	16	6	60	M4	7	23 g	100 pcs	400 pcs
100-010-606	H-75-C- 86	Stainless Steel (SUS304)	Polished	86	31.5	16	6	80	M4	7	28 g	100 pcs	400 pcs
100-010-607	H-75-C-108	Stainless Steel (SUS304)	Polished	108	32	18	8	100	M5	10	54 g	50 pcs	200 pcs
100-010-608	H-75-C-128	Stainless Steel (SUS304)	Polished	128	40	18	8	120	M5	10	70 g	50 pcs	200 pcs

BRACKET FOR STAINLESS STEEL HANDLE



H-42-Z



Features

- Bracket for stainless steel handle
- Suitable handle diameter sizes and screws are listed below

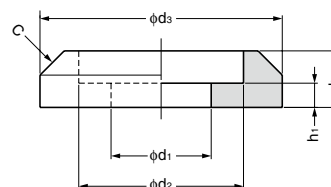

Item Code	Item Name	Material	Finish	h ₁	h ₂	d ₁	d ₂	d ₃	c	Handle Diameter	Screw Size	1 Set	Weight	Box	Carton
100-010-570	H-42-Z- 6	Stainless Steel (SUS304)	Polished	1.5	2.5	4.5	6.2	10	1	φ 6	M4	2 pcs	2.1 g	200 sets	2,000 sets
100-010-571	H-42-Z- 7	Stainless Steel (SUS304)	Polished	1	3	5.2	7.2	10	1	φ 7	M5	2 pcs	2.0 g	200 sets	2,000 sets
100-010-572	H-42-Z- 9	Stainless Steel (SUS304)	Polished	1	3	5.2	9.2	13	1	φ 9	M5	2 pcs	3.5 g	200 sets	2,000 sets
100-010-573	H-42-Z-10	Stainless Steel (SUS304)	Polished	1.5	3.5	6.2	10.2	15	1.5	φ10	M6	2 pcs	6.0 g	200 sets	2,000 sets
100-010-574	H-42-Z-12	Stainless Steel (SUS304)	Polished	1.5	4.5	8.2	12.2	18	1.5	φ12	M8	2 pcs	11.8 g	200 sets	2,000 sets

STAINLESS STEEL WIRE PULL



SWP

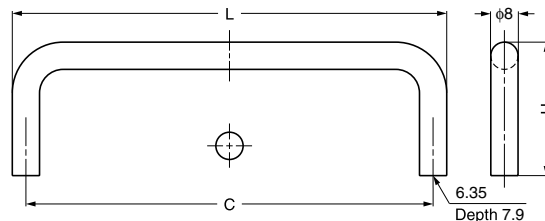

Item Code	Item Name	L	C	H	Weight	Box	Carton
100-023-434	SWP-630/S	84.2	76.2	34	71 g	20 pcs	200 pcs
100-023-435	SWP-635/S	96.9	88.9		78 g		
100-023-436	SWP-640/S	109.6	101.6		85 g		
100-023-437	SWP-696/S	104	96		81 g		

Material	Finish
316 Stainless Steel	Satin

STAINLESS STEEL WIRE PULL



SWF

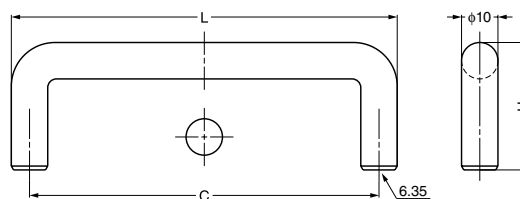
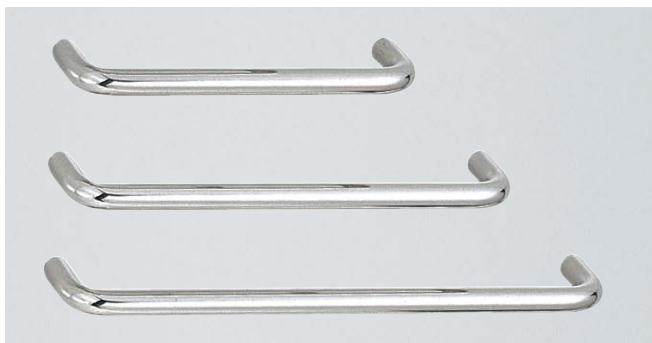

Item Code	Item Name	L	C	H	Weight	Box	Carton
100-023-438	SWF- 640	111	101.5	35	90 g	20 pcs	200 pcs
100-023-439	SWF- 650	136.5	127		110 g		
100-023-440	SWF- 660	162	152.5		130 g		
100-023-441	SWF- 690	238	228.5		200 g		
100-023-442	SWF-6120	314.5	305		270 g		

Material	Finish
316 Stainless Steel	Satin

TITANIUM HANDLE

H-42-CT



Features

- Titanium is a tough, lightweight, corrosion resistant material.
- Titanium rarely causes allergies even in people with metal allergies.
- Due to titanium's non-magnetic properties, can be used even on devices like MRIs Titanium screws also available
- H-42-C has handles available in stainless steel which are very close in size.

Recommended Screw

dx(Door thickness+5 - S)

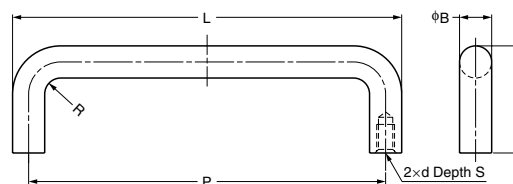

Item Code	Item Name	Material	Finish	L	H	B	P	R	d	S	Weight	Box	Carton
100-010-352	H-42-CT- 2	Titanium	Mirror	109	30	8	100	4.5	M5	8	37 g	20 pcs	80 pcs
100-010-351	H-42-CT- 4	Titanium	Mirror	130	40	10	120	5	M6	8	59 g	20 pcs	80 pcs
100-010-549	H-42-CT-15	Titanium	Mirror	162	50	12	150	6	M8	10	105 g	20 pcs	80 pcs



HANDLES, PULLS & KNOBS
STAINLESS STEEL WIRE PULL / TITANIUM HANDLE

STAINLESS STEEL HANDLE



KPH



Features

Light handle with hollow body.

Recommended Screw

$d \times (\text{Door thickness} + 10 - 15)$

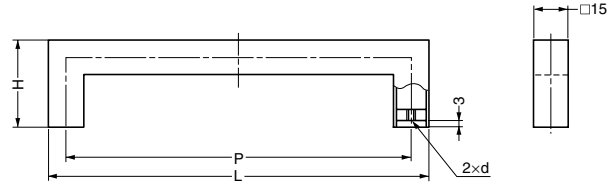

Item Code	Item Name	Material	Finish	L	H	P	d	Weight	Box	Carton
100-019-195	KPH-160	Stainless Steel (SUS304)	Satin	176	40	160	M4	80 g	10 pcs	100 pcs
100-019-196	KPH-192	Stainless Steel (SUS304)	Satin	208	40	192	M4	95 g	10 pcs	100 pcs
100-019-197	KPH-224	Stainless Steel (SUS304)	Satin	240	50	224	M5	125 g	10 pcs	100 pcs
100-019-198	KPH-256	Stainless Steel (SUS304)	Satin	272	50	256	M5	133 g	10 pcs	100 pcs
100-019-199	KPH-288	Stainless Steel (SUS304)	Satin	304	50	288	M5	142 g	10 pcs	100 pcs

STAINLESS STEEL HANDLE



40 SERIES

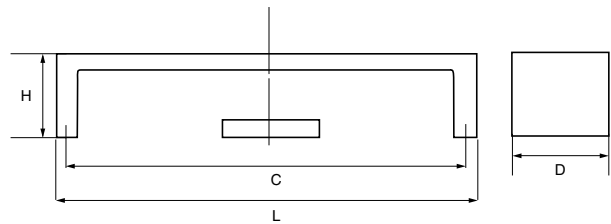

Item Code	Item Name	L	C	H	D	Weight	Box	Carton
-	40128	138	128	35	40	166 g	10 pcs	40 pcs
-	40160	170	160			198 g		
-	40192	202	192			219 g		

Material	Finish
304 Stainless Steel	Satin

STAINLESS STEEL HANDLE



DSI-110

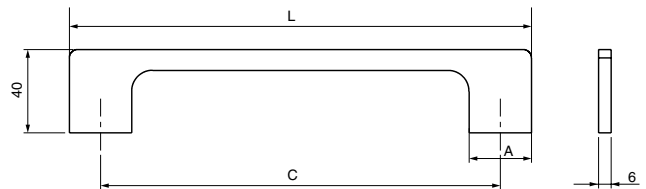

Item Code	Item Name	C	L	A	Weight	Box	Carton
-	DSI-110- 96	96	126	30	135 g	25 pcs	250 pcs
-	DSI-110-128	128	158		152 g		
-	DSI-110-160	160	190		190 g		
-	DSI-110-192	192	222		230 g	10 pcs	100 pcs
-	DSI-110-320	320	350		380 g		
-	DSI-110-512	512	542		610 g		

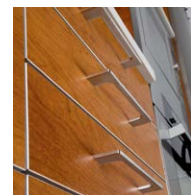

Material	Finish
304 Stainless Steel	Satin

STAINLESS STEEL HANDLE



DSI-120

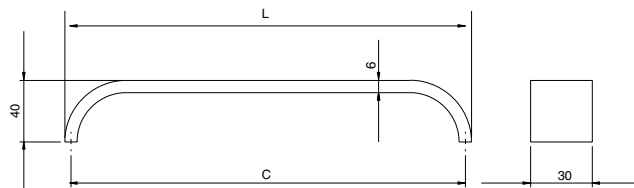

Item Code	Item Name	L	C	Weight	Box	Carton
-	DSI-120- 96	102	96	186 g	25 pcs	250 pcs
-	DSI-120-128	134	128	248 g		
-	DSI-120-160	166	160	275 g		
-	DSI-120-192	196	192	375 g	10 pcs	100 pcs
-	DSI-120-320	326	320	620 g		
-	DSI-120-512	518	512	992 g		

Material	Finish
304 Stainless Steel	Satin

STAINLESS STEEL HANDLE



50 SERIES

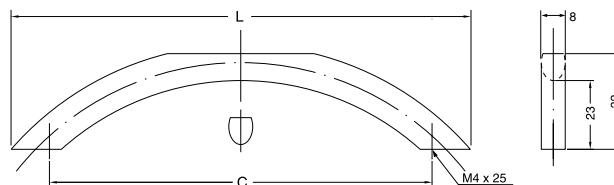

Item Code	Item Name	L	C	Weight	Box	Carton
-	5010	118	96	69 g	25 pcs	250 pcs
-	5011	151	128	86 g		
-	5012	189	160	103 g		
-	5013	224	192	122 g		

Material	Finish
304 Stainless Steel	Satin

STAINLESS STEEL HANDLE



30 SERIES

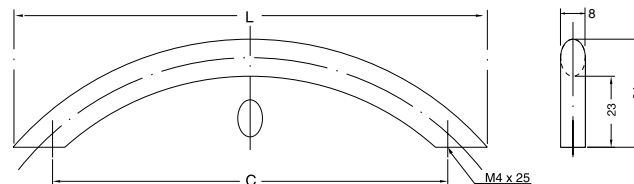

Item Code	Item Name	L	C	Weight	Box	Carton
-	3096	118	96	72 g	25 pcs	250 pcs
-	3097	151	128	90 g		
-	3098	189	160	108 g		
-	3099	224	192	128 g		

Material	Finish
304 Stainless Steel	Satin

HANDLES,
PULLS & KNOBS

STAINLESS STEEL HANDLE



82 SERIES

STAINLESS STEEL HANDLE

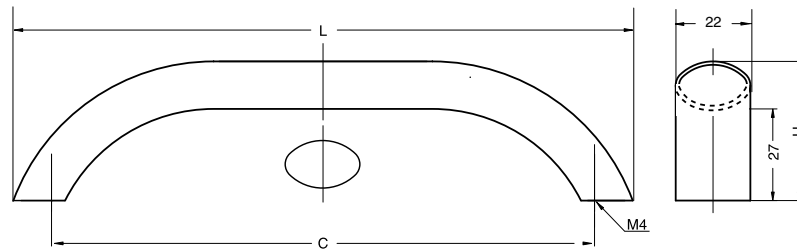

Item Code	Item Name	L	C	H	Weight	Box	Carton
-	8261	182	160	41	166 g	25 pcs	250 pcs
-	8262	214	192		179 g		
-	8263	246	224		192 g		
-	8264	342	320		231 g		

Material	Finish
304 Stainless Steel	Satin

STAINLESS STEEL HANDLE



90 SERIES

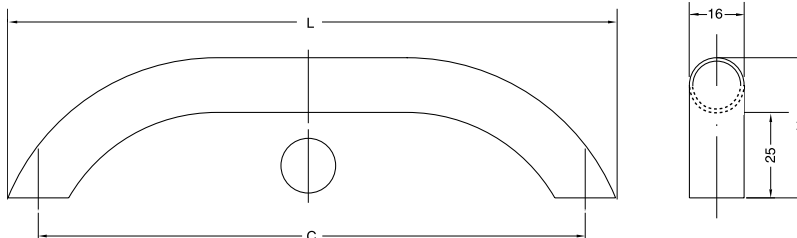

Item Code	Item Name	L	C	Weight	Box	Carton
-	9020	178	160	136 g	25 pcs	250 pcs
-	9021	210	192	144 g		

Material	Finish
304 Stainless Steel	Satin

STAINLESS STEEL HANDLE

STAINLESS 304 STEEL

I1020

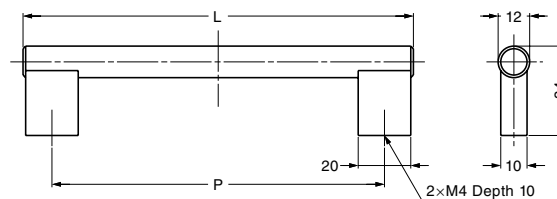

Item Code	Item Name	Material	Finish	L	P	Weight	Box
100-012-961	I1020128	Stainless Steel (SUS304)	Satin	150	128	159 g	25 pcs
100-012-962	I1020160	Stainless Steel (SUS304)	Satin	182	160	85 g	25 pcs
100-012-963	I1020192	Stainless Steel (SUS304)	Satin	214	192	93 g	25 pcs
100-012-964	I1020320	Stainless Steel (SUS304)	Satin	342	320	128 g	25 pcs
100-012-965	I1020492	Stainless Steel (SUS304)	Satin	514	492	175 g	25 pcs

HANDLES, PULLS & KNOBS

STAINLESS STEEL HANDLE

STAINLESS 304 STEEL

STAINLESS

DIH

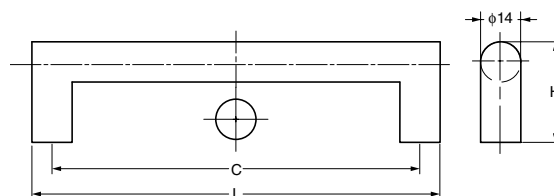

Item Code	Item Name	L	C	H	Weight	Box	Carton
-	DIH-096	110	96	35	57 g	25 pcs	250 pcs
100-023-511	DIH-128	142	128		66 g		
-	DIH-192	206	192		83 g		
-	DIH-342	356	342		123 g		
-	DIH-492	506	492		163 g		
-	DIH-592	606	592		189 g		

Material	Finish
304 Stainless Steel	Satin

STAINLESS STEEL HANDLE

STAINLESS STEEL HANDLE

STAINLESS 304 STEEL

I1014



Recommended Screw

Truss head screw M4x(Door thickness+5 - 10)

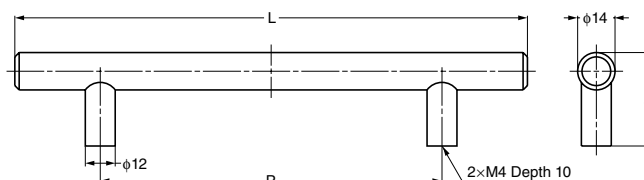

Item Code	Item Name	Material	Finish	L	P	Weight	Box
100-012-629	I1014128	Stainless Steel (SUS304)	Satin	192	128	113 g	25 pcs
100-012-628	I1014192	Stainless Steel (SUS304)	Satin	256	192	136 g	25 pcs
100-012-627	I1014342	Stainless Steel (SUS304)	Satin	406	342	187 g	25 pcs
100-012-626	I1014492	Stainless Steel (SUS304)	Satin	556	492	216 g	25 pcs

HANDLE (STAINLESS, TITANIUM)



2LC



Features

- Wide design for easy gripping
- Available in both titanium (light, strong and corrosion resistant) and SUS316 equivalent (highly corrosion resistant) SCS314
- Titanium rarely causes allergies even in people with metal allergies.
- Due to titanium's non-magnetic properties, can be used even on devices like MRIs Titanium screws also available

Parts Included (For only stainless handle)

Pan head tapping screw (SUS)

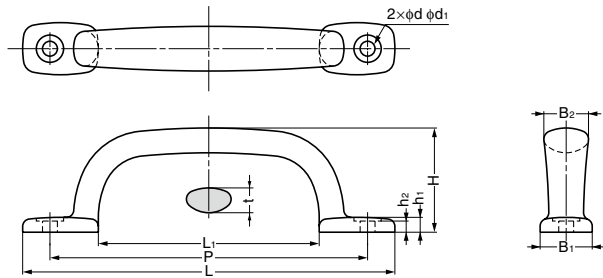

Item Code	Item Name	Material	Finish	L	L ₁	P	B ₁	B ₂	H	h ₁	h ₂	t	d	d ₁	Screw	Weight	Box
100-010-355	2LC- 80TI	Titanium	Shot Blast	80	32	64	16	14	35	5.5	4	8	5	9.5	-	37 g	20 pcs
100-010-354	2LC-120TI	Titanium	Shot Blast	120	64	96	18	16	36	5.5	4.5	9	5	9.5	-	62 g	15 pcs
100-010-353	2LC-150TI	Titanium	Shot Blast	150	89	128	21	18	42	6	4.5	10	6	11	-	96 g	10 pcs
100-010-131	2LC- 80	Stainless Steel (SCS14)	Mirror	80	32	64	16	14	35	5.5	4	8	5	9.5	4x20	70 g	12 pcs
100-010-132	2LC-120	Stainless Steel (SCS14)	Mirror	120	64	96	18	16	36	5.5	4.5	9	5	9.5	4x20	106 g	8 pcs
100-010-133	2LC-150	Stainless Steel (SCS14)	Mirror	150	89	128	21	18	42	6	4.5	10	6	11	5x32	172 g	6 pcs
100-010-134	2LC-180	Stainless Steel (SCS14)	Mirror	180	118	160	23	20	45	6.5	5	10	6	11	5x32	225 g	3 pcs

*SCS14 is equivalent of SUS316.

STAINLESS STEEL HANDLE



4LC



Features

Titanium handle is available as a special order.

Parts Included

Pan head tapping screw (SUS)

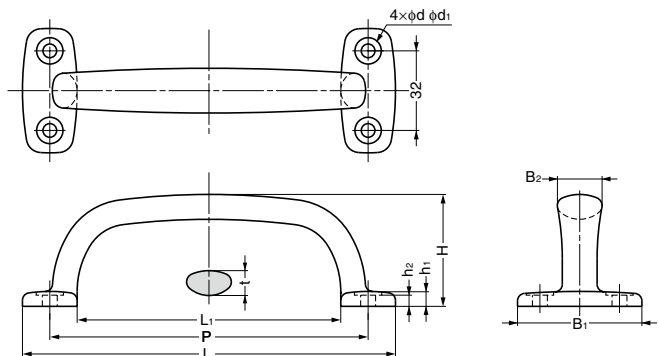

Item Code	Item Name	Material	Finish	L	L ₁	P	B ₁	B ₂	H	h ₁	h ₂	t	d	d ₁	Screw	Weight	Box
100-010-135	4LC- 82	Stainless Steel (SCS14)	Mirror	82	46	64	48	16	36.5	5.5	4	8	5	9.5	4x20	110 g	8 pcs
100-010-136	4LC-114	Stainless Steel (SCS14)	Mirror	114	78	96	48	16	40	6	4.5	9	5	9.5	4x20	148 g	6 pcs
100-010-137	4LC-150	Stainless Steel (SCS14)	Mirror	150	106	128	50	18	45	6	4.5	10	6	11	5x32	235 g	3 pcs
100-010-138	4LC-180	Stainless Steel (SCS14)	Mirror	180	140	160	50	20	48	6.5	5	10	6	11	5x32	286 g	2 pcs

*SCS14 is equivalent of SUS316.

STAINLESS STEEL HANDLE



EC-Y



Parts Included

Raised countersunk head tapping screw 4x20 (SUS)

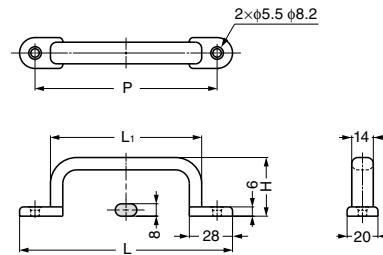

Item Code	Item Name	Material	Finish	L	L ₁	H	P	Weight	Box
100-012-831	EC-Y-140	Stainless Steel (SUS303)	Mirror	140	100	38	120	148 g	5 pcs
100-012-832	EC-Y-160	Stainless Steel (SUS303)	Mirror	160	120	40	140	168 g	3 pcs
100-012-833	EC-Y-190	Stainless Steel (SUS303)	Mirror	190	150	42	170	216 g	2 pcs

STAINLESS STEEL HANDLE



EC-H



Parts Included

Raised countersunk head tapping screw 4x20 (SUS)

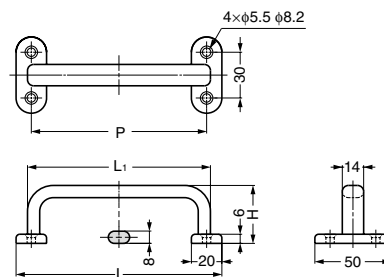

Item Code	Item Name	Material	Finish	L	L ₁	H	P	Weight	Box
100-010-056	EC-H-135	Stainless Steel (SUS303)	Mirror	135	120	40	115	220 g	5 pcs
100-010-057	EC-H-165	Stainless Steel (SUS303)	Mirror	165	150	42	145	260 g	3 pcs

HANDLES,
PULLS & KNOBS

STAINLESS STEEL HANDLE

STAINLESS STEEL HANDLE



FT-65, FT-80, FT-100



Parts Included

Raised countersunk head wood screw (SUS)

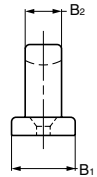
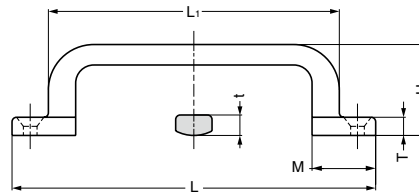
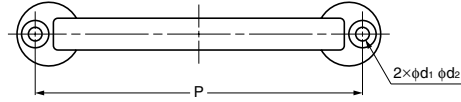

Item Code	Item Name	Material	Finish	L	L ₁	B ₁	B ₂	H	T	t	M	P	d ₁	d ₂	Screw	Weight	Box	Carton
100-012-847	FT- 65	Stainless Steel (SCS13)	Mirror	65	47	13	7	16	3.5	4	13	57	3.3	6.4	3.1×16	19 g	40 pcs	480 pcs
100-012-848	FT- 80	Stainless Steel (SCS13)	Mirror	80	61	14	8	20	4	4.5	14	72	3.3	6.4	3.1×16	32 g	30 pcs	360 pcs
100-012-849	FT-100	Stainless Steel (SCS13)	Mirror	100	75	18	10	25	5	5.5	18	88	4.1	8	3.8×20	58 g	20 pcs	240 pcs

*SCS13 is equivalent of SUS304.

STAINLESS STEEL HANDLE



FT-120, FT-150



Parts Included

Raised countersunk head wood screw (SUS)

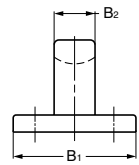
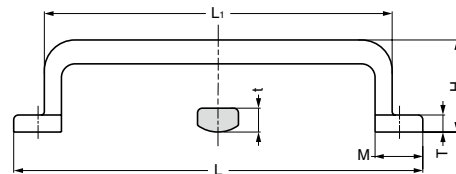
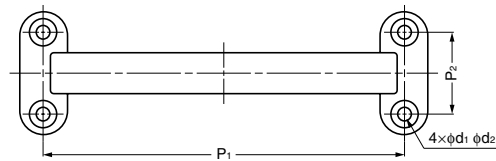

Item Code	Item Name	Material	Finish	L	L ₁	B ₁	B ₂	H	T	t	M	P ₁	P ₂	d ₁	d ₂	Screw	Weight	Box	Carton
100-010-067	FT-120	Stainless Steel (SCS13)	Mirror	120	102	36	12	27	5	7	14	106	24	4.1	8	3.8×20	117 g	10 pcs	120 pcs
100-010-068	FT-150	Stainless Steel (SCS13)	Mirror	150	129	45	15	33	6	8	18	132	30	5.3	10.4	5.1×25	217 g	5 pcs	40 pcs

*SCS13 is equivalent of SUS304.

STAINLESS STEEL HANDLE



FT-110S



Recommended Screw

M4 Screw

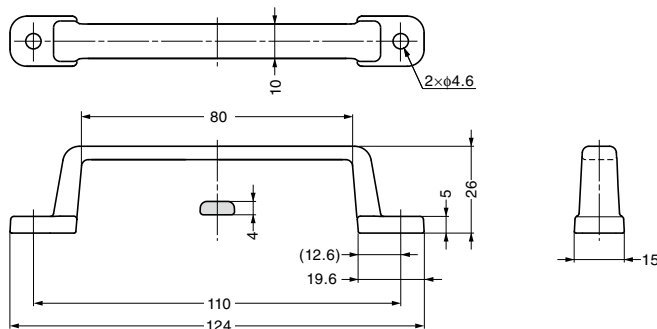

Item Code	Item Name	Material	Finish	Weight	Box	Carton
100-019-029	FT-110S	Stainless Steel (SCS13)	Satin	63 g	50 pcs	200 pcs

*SCS13 is equivalent of SUS304.

STAINLESS STEEL HANDLE



XL-CUY



Features

Exquisite combination of satin and mirror finishes

Parts Included

Raised countersunk head tapping screw 4x20 (SUS)

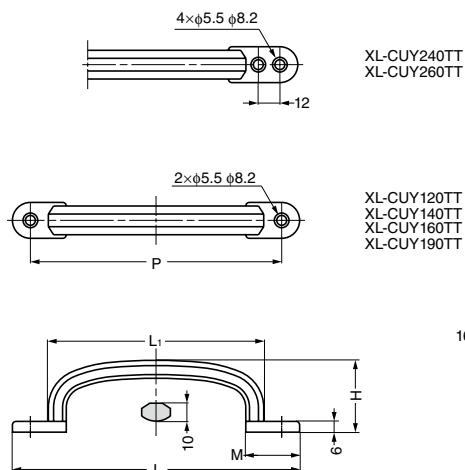

Item Code	Item Name	Material	Finish	L	L ₁	H	M	P	Weight	Box
100-012-834	XL-CUY120TT	Stainless Steel (SUS303)	Mirror and Satin Combination	118	80	36	30	100	153 g	5 pcs
100-012-835	XL-CUY140TT	Stainless Steel (SUS303)	Mirror and Satin Combination	138	100	38	30	120	188 g	5 pcs
100-012-836	XL-CUY160TT	Stainless Steel (SUS303)	Mirror and Satin Combination	158	120	40	30	140	199 g	3 pcs
100-012-837	XL-CUY190TT	Stainless Steel (SUS303)	Mirror and Satin Combination	188	150	42	30	170	235 g	2 pcs
100-012-838	XL-CUY240TT	Stainless Steel (SUS303)	Mirror and Satin Combination	238	180	44	40	196	290 g	2 pcs
100-012-839	XL-CUY260TT	Stainless Steel (SUS303)	Mirror and Satin Combination	258	200	46	40	216	311 g	2 pcs



HANDLES,
PULLS & KNOBS

STAINLESS STEEL HANDLE

STAINLESS STEEL HANDLE



FT-200, FT-280



Parts Included

Binding head tapping screw 6x35 (SUS)

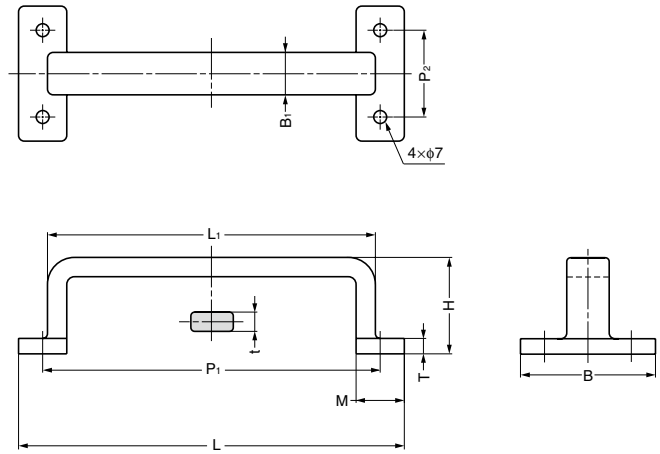

Item Code	Item Name	Material	Finish	L	L ₁	B	B ₁	H	T	t	M	P ₁	P ₂	Weight	Box	Carton
100-010-069	FT-200	Stainless Steel (SCS14)	Mirror	200	170	70	22	50	8	10	25	175	45	697 g	1 pc	20 pcs
100-010-070	FT-280	Stainless Steel (SCS14)	Mirror	280	250	80	26	62	10	12	27	253	55	1250 g	1 pc	10 pcs

*SCS14 is equivalent of SUS316.

STAINLESS STEEL HANDLE



FT-S280



Features

- Ideal for harsh and high corrosion environments.
- Higher profile allows for easy gripping with gloved hand.

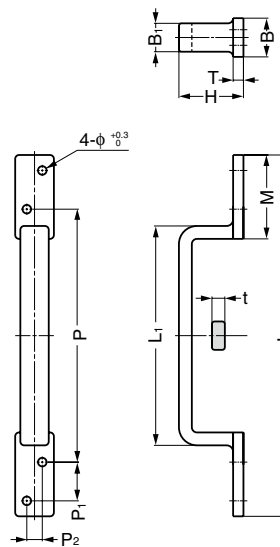

Item Code	Item Name	Material	Finish	L	L ₁	B	B ₁	H	T	t	M	P	P ₁	P ₂	Weight	Box	Carton
100-010-071	FT-S280	Stainless Steel (SCS14)	Mirror	280	170	30	22	50	8	10	65	196	30	12	700 g	1 pc	20 pcs

*SCS14 is equivalent of SUS316.

STAINLESS STEEL HANDLE



MG



Features

- SEMI compliant (SEMI S8-0701)
- Very strong handle, passed a 1960N (200kgf) load capacity test
- High profile and wide design allow for easy gripping even while wearing protective gloves. Recommended for use on work cabinets
- Compatible with truss screw heads.

Recommended Screw

Truss head screw

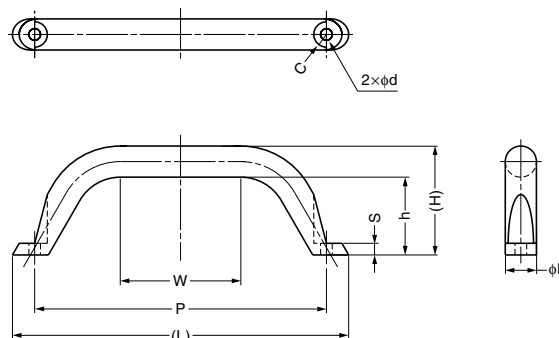

Item Code	Item Name	Material	Finish	L	H	P	D	W	h	S	C	d	Recommended Screw	Weight	Box	Carton
100-010-483	MG-150	Stainless Steel (SUS316)	Mirror	172.8	56	150	16	62	40	6	R6.5	6	M5	314 g	10 pcs	40 pcs
100-010-484	MG-190	Stainless Steel (SUS316)	Mirror	216.7	63	190	18	92	45	8	R7.5	7	M6	470 g	5 pcs	20 pcs
100-010-485	MG-250	Stainless Steel (SUS316)	Mirror	275.5	68	250	18	145	50	8	R7.5	7	M6	607 g	5 pcs	20 pcs
100-021-952	MG-230T	Stainless Steel (SUS316)	Mirror	260	70	230	20	129	50	10	R9	9	M8	678 g	5 pcs	20 pcs
100-021-953	MG-300T	Stainless Steel (SUS316)	Mirror	330	70	300	20	199	50	10	R9	9	M8	859 g	5 pcs	20 pcs

STAINLESS STEEL HANDLE



US



Features

- Rubber grip allows for an easy and comfortable grip.
- Light weight design.

Parts Included

Raised countersunk head wood screw (SUS)

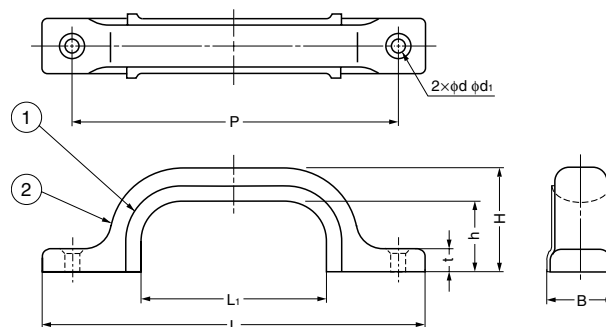

No.	Material	Finish/Colour
①	Elastomer (TPE)	Black
②	Stainless Steel (SUS304)	Mirror and Satin Combination

Item Code	Item Name	Finish	L	L ₁	P	B	H	h	t	d	d ₁	Screw	Weight	Box	Carton
100-012-243	US- 70S	Satin	70	20	54	17	28	21	5.5	3.3	6.6	3.1×16	20 g	20 pcs	200 pcs
100-012-240	US- 70M	Mirror	70	20	54	17	28	21	5.5	3.3	6.6	3.1×16	20 g	20 pcs	200 pcs
100-012-244	US-120S	Satin	120	57	102	19	32	21	6.5	3.8	7.6	3.5×20	45 g	20 pcs	200 pcs
100-012-241	US-120M	Mirror	120	57	102	19	32	21	6.5	3.8	7.6	3.5×20	45 g	20 pcs	200 pcs
100-012-245	US-160S	Satin	160	88	140	22	37.5	23	7.5	4.1	8.1	4.1×25	70 g	10 pcs	100 pcs
100-012-242	US-160M	Mirror	160	88	140	22	37.5	23	7.5	4.1	8.1	4.1×25	70 g	10 pcs	100 pcs

HANDLE



LX-110



Parts Included

Truss head screw M4x25

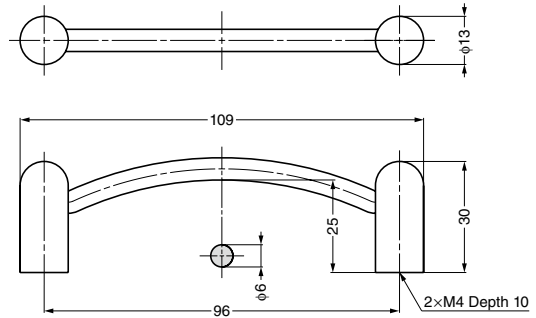

Item Code	Item Name	Material	Finish	Weight	Box	Carton
100-013-231	LX-110PB	Brass	Polished	85 g	10 pcs	160 pcs
100-013-232	LX-110WB	Brass	Satin Nickel	85 g	10 pcs	160 pcs

TAMAZUSA HANDLE (GOLD PLATED)



TMH



Features

- This interior concept is inspired by the splendor and traditional beauty of 16th century Japanese culture. By transplanting these designs into the modern world, the "Tamazusa" series was born. The series emulates "Ryusui" flowing water Japanese design and has gentle soft lines, providing a comforting and desirable aesthetic.
- The Tamazusa series has knobs, door handles and lever handles.
- This handle is covered in 24k gold plating.

Parts Included

Truss head screw M5x30 (SUS)

Option

Base plate TMH-M35



Without base plate

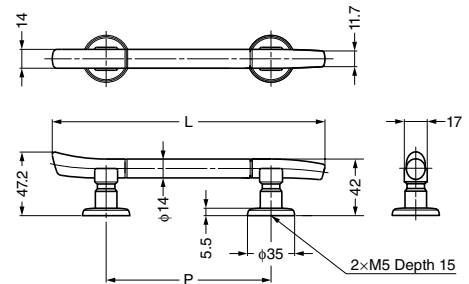

Base Plate (Sold Separately)

Item Code	Item Name	Material	Finish	Weight
100-010-736	TMH-M35	Brass	24K Gold Plating	28 g

Body

Item Code	Item Name	Material	Finish	L	P	Weight
100-010-732	TMH- 96	Brass	24K Gold Plating, Black Nickel (Ring)	176	96	300 g
100-010-733	TMH-128	Brass	24K Gold Plating, Black Nickel (Ring)	208	128	338 g
100-010-734	TMH-160	Brass	24K Gold Plating, Black Nickel (Ring)	240	160	349 g
100-010-735	TMH-192	Brass	24K Gold Plating, Black Nickel (Ring)	272	192	383 g



HANDLE



K255



Features

Created from a mix of ceramic and brass.

Parts Included

Truss head screw M4x28

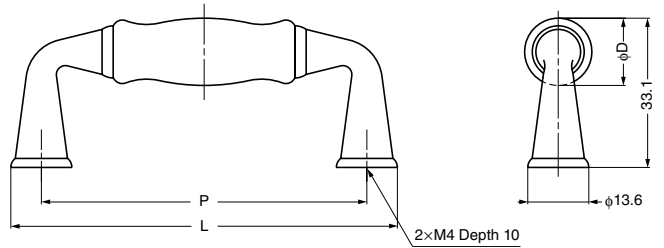

HANDLES,
PULLS & KNOBS

HANDLE

Item Code	Item Name	Material	Finish	L	P	D	Weight	Box	Carton
100-012-773	K255-76	Brass/Ceramic	Brass, Clear	89.8	76.2	15.1	58 g	30 pcs	300 pcs
100-012-774	K255-96	Brass/Ceramic	Brass, Clear	109.6	96	17	73 g	20 pcs	200 pcs

HANDLE



K259



Parts Included

Truss head screw M4x28

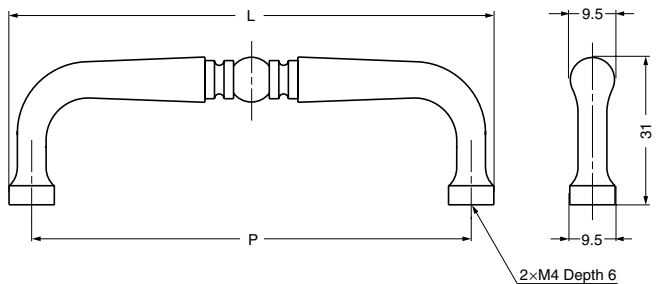

Item Code	Item Name	Material	Finish	L	P	Weight	Box	Carton
100-012-775	K259-76PB	Brass	Brass, Clear	85.7	76.2	45 g	30 pcs	300 pcs
100-012-776	K259-76AB	Brass	Brass Antique	85.7	76.2	45 g	30 pcs	300 pcs
100-012-777	K259-96PB	Brass	Brass, Clear	105.5	96	50 g	30 pcs	300 pcs
100-012-778	K259-96AB	Brass	Brass Antique	105.5	96	50 g	30 pcs	300 pcs

HANDLE



122HD



Parts Included

Truss head screw M4×30

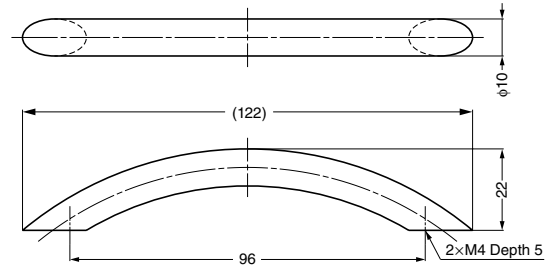

Item Code	Item Name	Material	Finish	Weight	Box	Carton
100-014-200	122HD-BCR	Brass	Black Chrome	82 g	20 pcs	200 pcs
100-014-202	122HD-ABS	Brass	Brass Antique	82 g	20 pcs	200 pcs
100-014-203	122HD-W	Brass	White Lacquer	82 g	20 pcs	200 pcs
100-014-207	122HD-PNI	Brass	Pearl Nickel	82 g	20 pcs	200 pcs
100-014-205	122HD-G	Brass	Gold	82 g	20 pcs	200 pcs
100-014-206	122HD-CR	Brass	Chrome	82 g	20 pcs	200 pcs

HANDLE



K281



Parts Included

Truss head screw M4×25

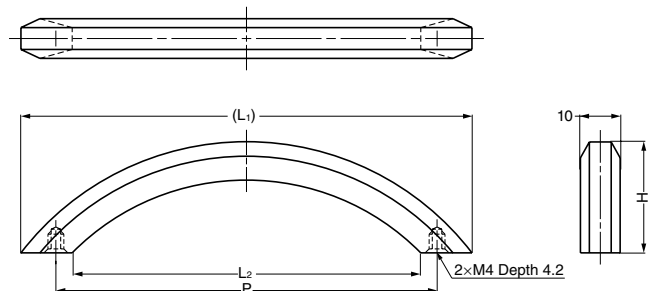

Item Code	Item Name	Material	Finish	L1	L2	H	P	Weight	Box	Carton
100-012-779	K281- 96PB	Brass	Clear	113.5	88.5	28	96	80 g	20 pcs	200 pcs
100-012-780	K281- 96CR	Brass	Chrome	113.5	88.5	28	96	80 g	20 pcs	200 pcs
100-012-781	K281- 96BN	Brass	Black Nickel	113.5	88.5	28	96	80 g	20 pcs	200 pcs
100-012-782	K281- 96SN	Brass	Soft Nickel	113.5	88.5	28	96	80 g	20 pcs	200 pcs
100-012-783	K281-128PB	Brass	Clear	146	120	30	128	111 g	20 pcs	200 pcs
100-012-784	K281-128CR	Brass	Chrome	146	120	30	128	111 g	20 pcs	200 pcs
100-012-785	K281-128BN	Brass	Black Nickel	146	120	30	128	111 g	20 pcs	200 pcs
100-012-786	K281-128SN	Brass	Soft Nickel	146	120	30	128	111 g	20 pcs	200 pcs

HANDLE

ATO



Parts Included

Nut

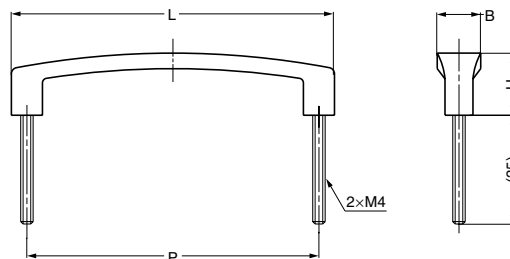

HANDLES,
PULLS & KNOBS

HANDLE

Item Code	Item Name	Material	Finish	L	H	B	P	Weight	Box	Carton
100-010-927	ATO-A209	Brass	Satin Nickel	90	18	13	80	65 g	30 pcs	300 pcs
100-010-928	ATO-A208	Brass	Satin Nickel	104	20	14	94	80 g	25 pcs	250 pcs
100-010-929	ATO-A207	Brass	Satin Nickel	121	21	15	112	110 g	15 pcs	150 pcs

OVAL HANDLE

OPE-110



Parts Included

Nut

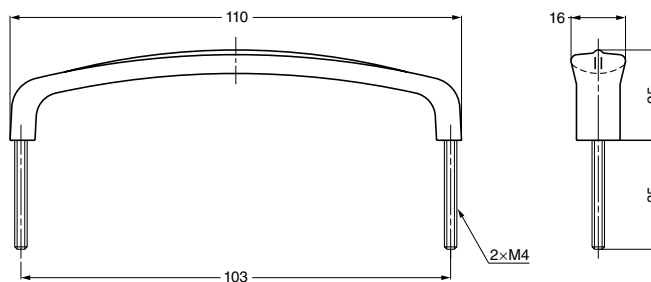

Item Code	Item Name	Material	Finish	Weight	Box	Carton
100-010-932	OPE-110	Brass	Satin Nickel	83 g	20 pcs	200 pcs

ROUNDED HANDLE

MRB-A



Parts Included

Nut

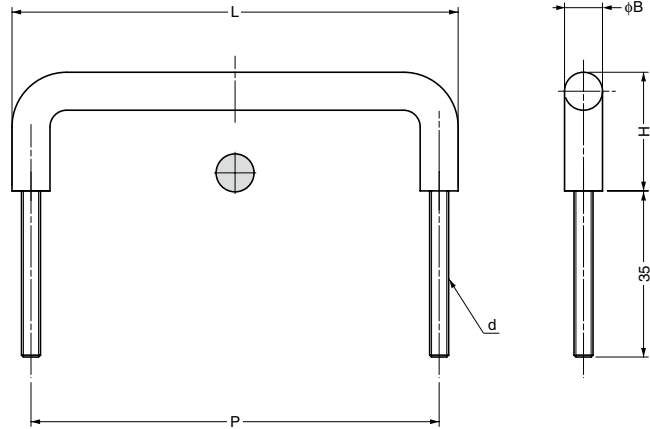

Item Code	Item Name	Material	Finish	L	H	B	P	d	Weight	Box	Carton
100-010-280	MRB-A283	Brass	Satin Nickel	60	18	6	54	M3	21 g	70 pcs	700 pcs
100-010-281	MRB-A282	Brass	Satin Nickel	76	23	7	69	M4	39 g	50 pcs	500 pcs
100-010-282	MRB-A281	Brass	Satin Nickel	94	25	8	86	M4	56 g	35 pcs	350 pcs
100-010-283	MRB-A280	Brass	Satin Nickel	105	27	8	97	M4	62 g	30 pcs	300 pcs
100-010-284	MRB-A279	Brass	Satin Nickel	122	27	8	114	M4	70 g	20 pcs	200 pcs

HANDLE



DLB



Parts Included

Truss head screw M4x28

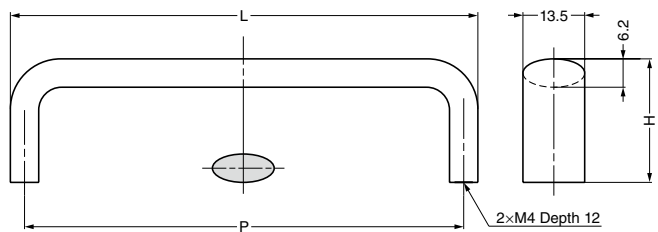

Item Code	Item Name	Material	Finish	L	H	P	Weight	Box	Carton
100-907-405	DLB- 96PB	Brass	Mirror	102.2	27	96	79 g	20 pcs	200 pcs
100-012-500	DLB- 96CR	Brass	Chrome	102.2	27	96	79 g	20 pcs	200 pcs
100-907-408	DLB-128PB	Brass	Mirror	134.2	28	128	96 g	15 pcs	150 pcs
100-012-502	DLB-128CR	Brass	Chrome	134.2	28	128	96 g	15 pcs	150 pcs

SQUARE FOOT HANDLE



KAKU



Parts Included

- KAKU-A161 : Truss head screw M3x28
- KAKU-A160, KAKU-A159 : Truss head screw M4x28

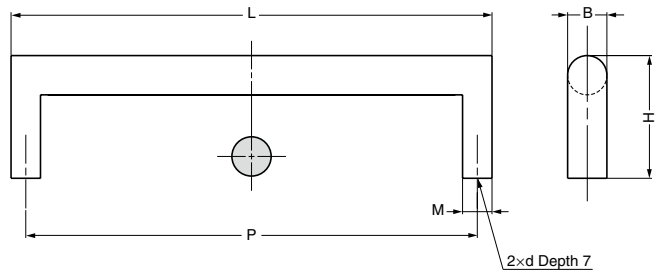

Item Code	Item Name	Material	Finish	L	H	B	P	M	d	Weight	Box	Carton
100-010-921	KAKU-A161	Brass	Satin Nickel	84	24	7	78	7	M3	50 g	35 pcs	420 pcs
100-010-922	KAKU-A160	Brass	Satin Nickel	99	25	8	92	8	M4	65 g	30 pcs	360 pcs
100-010-923	KAKU-A159	Brass	Satin Nickel	124	29	9	113	11	M4	103 g	20 pcs	240 pcs

HANDLES,
PULLS & KNOBS

HANDLE

RECTANGULAR STRAIGHT HANDLE



HIRA



Parts Included

Truss head screw M4x28

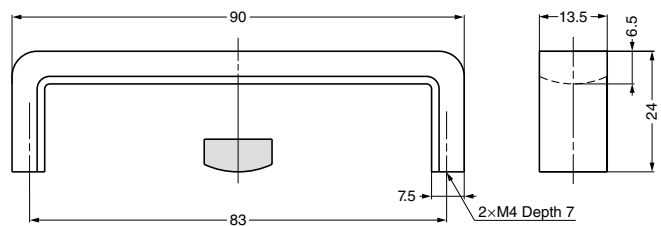

Item Code	Item Name	Material	Finish	Weight	Box	Carton
100-010-924	HIRA-A012	Brass	Satin Nickel	98 g	20 pcs	240 pcs



DIE CAST HANDLE

SAZ-121CR

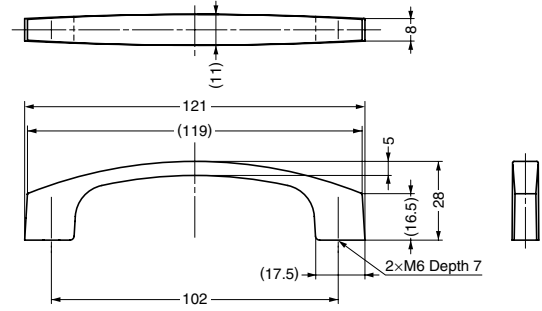

Item Code	Item Name	Material	Finish	Weight	Box	Carton
100-010-105	SAZ-121CR	Zinc Alloy (ZDC)	Chrome	67 g	50 pcs	200 pcs

HANDLE

SAZ-122

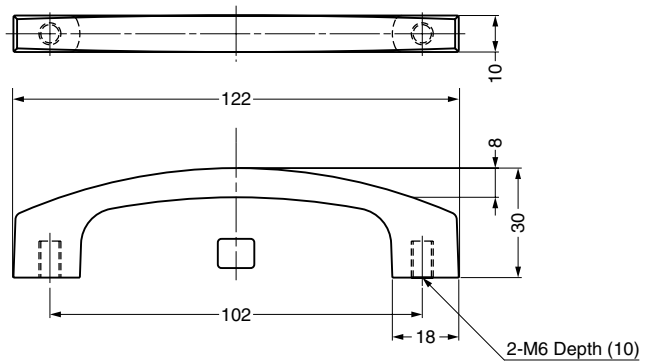

Item Code	Item Name	Material	Finish	Weight	Box	Carton
100-019-790	SAZ-122	Zinc Alloy (ZDC)	Chrome	85 g	40 pcs	400 pcs

SQUARE FOOT HANDLE

AKH

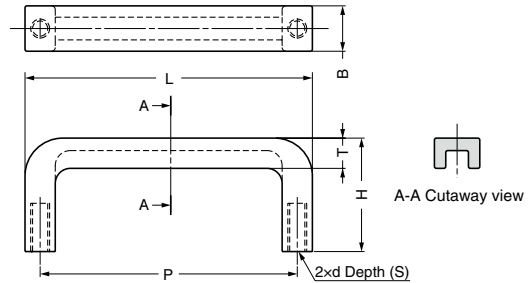

HANDLES,
PULLS & KNOBS

HANDLE

Item Code	Item Name	Material	Finish	L	H	B	T	P	d	S	Weight	Box
100-019-803	AKH- 76	Zinc Alloy (ZDC)	Chrome	76	30	12	8	68	M5	8	55 g	50 pcs
100-019-799	AKH-108	Zinc Alloy (ZDC)	Chrome	108	30	14	8	100	M5	8	90 g	30 pcs
100-019-802	AKH-120	Zinc Alloy (ZDC)	Chrome	120	40	16	10	110	M6	8	145 g	20 pcs
100-019-801	AKH-130	Zinc Alloy (ZDC)	Chrome	130	40	16	10	120	M6	8	157 g	20 pcs
100-010-575	AKH-200	Zinc Alloy (ZDC)	Chrome	200	50	18	12	188	M8	10	276 g	30 pcs

DIE CAST HANDLE



936



Remarks

Screws are not included in 936-55-SNI and 936-100-SNI (Soft Nickel finish).

Parts Included

- 936-55-SCR : Truss head screw M4x25
- 936-100-DC : Truss head screw M4x28

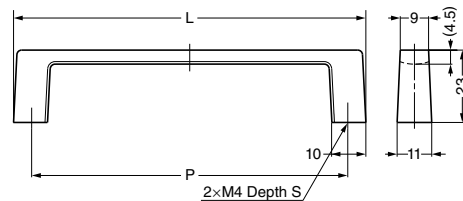

Item Code	Item Name	Material	Finish	L	P	S	Weight	Box	Carton
100-010-101	936-55-SCR	Zinc Alloy (ZDC)	Satin Chrome	66.5	55	8	46 g	50 pcs	200 pcs
100-019-096	936-55-SNI	Zinc Alloy (ZDC)	Soft Nickel	66.5	55	8	46 g	50 pcs	200 pcs
100-010-003	936-100-DC	Zinc Alloy (ZDC)	Dull Chrome/Clear	112	100.5	10	57 g	50 pcs	200 pcs
100-019-127	936-100-SNI	Zinc Alloy (ZDC)	Soft Nickel	112	100.5	10	57 g	50 pcs	200 pcs



HANDLE



XLA-HA



Features

Straight linear design provides a visually appealing design that integrates very easily.

Parts Included

Truss head screw M4x25

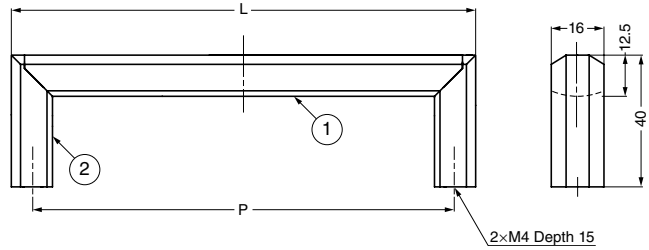

No.	Part Name	Material	Finish
①	Handle	Aluminium Alloy	Anodized Silver
②	Leg	Zinc Alloy (ZDC)	Dull Chrome

Item Code	Item Name	L	P	Weight	Box	Carton
100-010-059	XLA-HA 96	109	96	129 g	20 pcs	80 pcs
100-010-060	XLA-HA128	141	128	144 g	20 pcs	80 pcs
100-010-061	XLA-HA192	205	192	149 g	20 pcs	80 pcs
100-010-062	XLA-HA256	269	256	169 g	10 pcs	60 pcs
100-010-063	XLA-HA320	333	320	189 g	10 pcs	60 pcs

PITCH ADJUSTABLE HANDLE



KM-96



Parts Included

Truss head screw M4x30

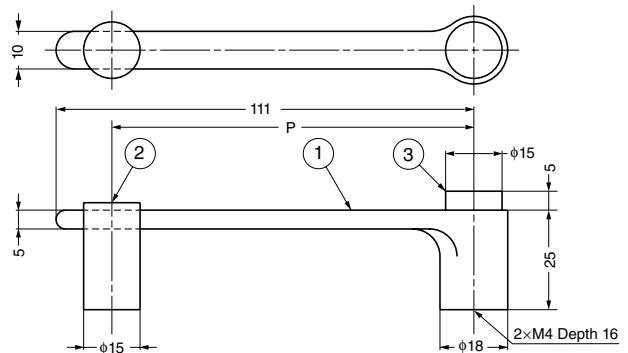

No.	Part Name
①	Handle
②	Bracket
③	Button (Fixed Type)

Item Code	Item Name	Material	Finish	P	Weight	Box	Carton
100-010-618	KM-96SN	Zinc Alloy (ZDC)	Satin Nickel/Clear	26.5 - 98.5	174 g	30 pcs	60 pcs
100-010-617	KM-96SG	Zinc Alloy (ZDC)	Satin Gold/Clear	26.5 - 98.5	174 g	30 pcs	60 pcs

HANDLE

KMH



Features

- The handle can be installed by screwing in from the front and then the screws can be hidden using handle caps (which are sold separately). The handle caps come in four different colors.
- The top of the handle is a stylish flat surface while the sides are rounded and easy to grab.
- The caps are hard to take off and prevent unintentional removal.
- We can also prepare caps in different colors. For this type of order the MOQ is 10,000 pieces.

Recommended Screw

Hexagon top bolt or Pan head screw M5, M5

Installation

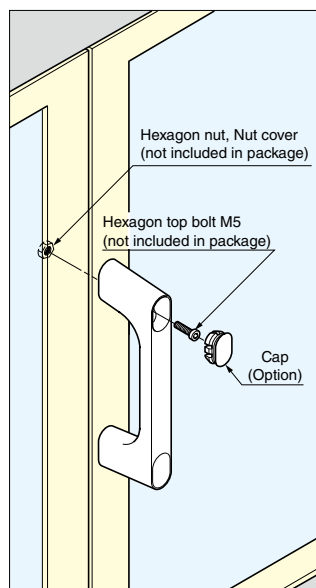

Caps (Option)



Without Cap

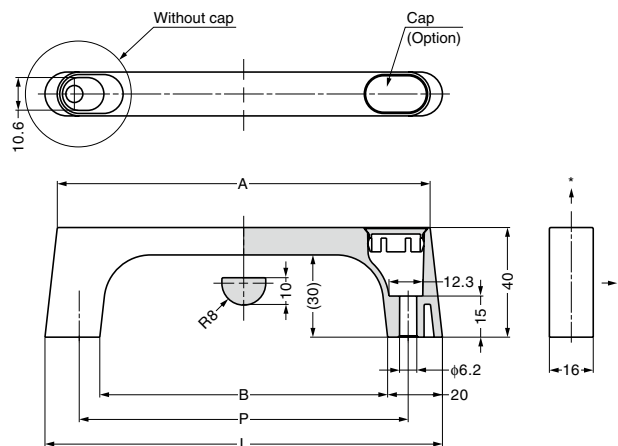
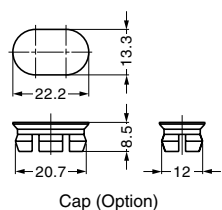

Body

Item Code	Item Name	Material	Finish	L	A	B	P	Load Capacity	Weight	Carton	
100-024-063	KMH-100	Zinc Alloy (ZDC)	Satin Chrome	125	116	85	100	500 N	51 kgf	162 g	100 pcs
100-024-064	KMH-120	Zinc Alloy (ZDC)	Satin Chrome	145	136	105	120	500 N	51 kgf	180 g	60 pcs
100-024-065	KMH-150	Zinc Alloy (ZDC)	Satin Chrome	175	166	135	150	500 N	51 kgf	206 g	60 pcs

Load capacity for two directions (see *marks on above figure).

Caps (Option) (Sold by piece)

Item Code	Item Name	Material	Colour	Weight
100-024-066	KMHC-WT	PBT Plastic	White	1.0 g
100-024-067	KMHC-GR	PBT Plastic	Grey	1.0 g
100-024-068	KMHC-BU	PBT Plastic	Light Blue	1.0 g
100-024-924	KMHC-BL	PBT Plastic	Black	1.0 g

HANDLES, PULLS & KNOBS

HANDLE

HANDLE

MJH



Features

- Screw can be attached from either the front or the back. Separately sold caps hide the screw connections. The caps are available in 3 different colors.
- The inside portion of the handle is rounded and easy to grab.
- The caps are hard to take off and prevent unintentional removal.
- We can also prepare caps in different colors. For this type of order the MOQ is 3,000 pieces.
- The MJH-150 is SEMI compliant (SEMI S8-0308).

Remarks

Only hexagon top bolt are applicable.

Recommended Screw

- MJH-93 : Hexagon top bolt M6
- MJH-120, MJH-150 : Hexagon top bolt M8

Caps (Option)



Installation

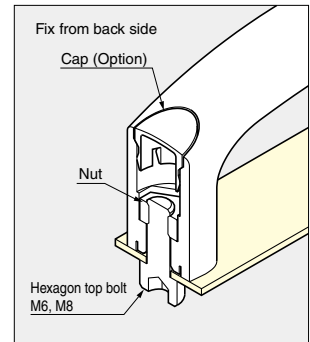
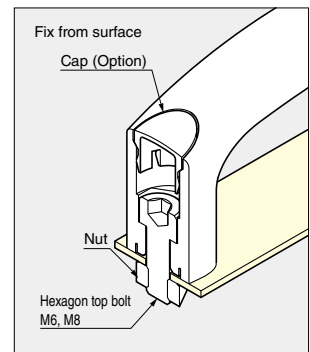
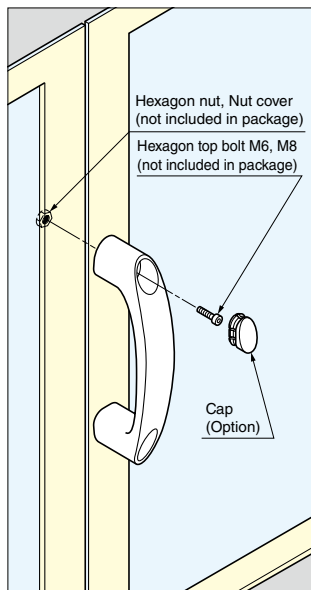

*Screws are applicable from both inside and outside.

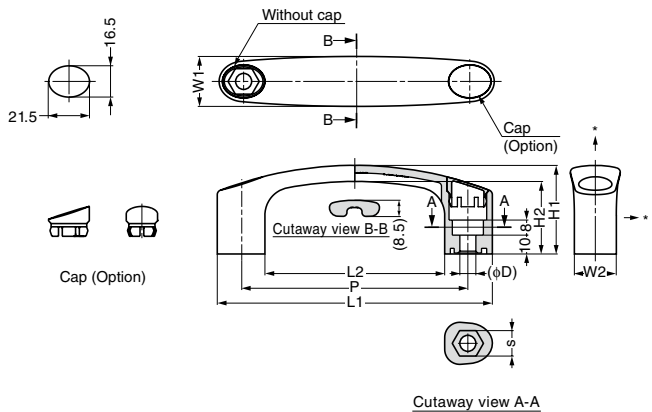

Body

Item Code	Item Name	Material	Colour	P	L1	L2	D	s	H1	H2	W1	W2	Load Capacity	Weight	Carton	
100-026-534	MJH-93	Reinforced Nylon	Black	93	116.5	68.5	6.5	10.2	42	33.5	25	19.2	450 N	46 kgf	35 g	100 pcs
100-026-535	MJH-120	Reinforced Nylon	Black	120	143	96	8.5	13.2	47	38.5	26.5	19	450 N	46 kgf	42 g	50 pcs
100-026-536	MJH-150	Reinforced Nylon	Black	150	173	126	8.5	13.2	52	43.5	28	18.8	450 N	46 kgf	52 g	50 pcs

Load capacity for two directions (see *marks on above figure).

Caps (Option) (Sold by piece)

Item Code	Item Name	Material	Colour	Weight
100-026-537	MJHC-BL	Reinforced Nylon	Black	1.0 g
100-026-538	MJHC-GR	Reinforced Nylon	Grey	1.0 g
100-026-539	MJHC-YE	Reinforced Nylon	Yellow	1.0 g

HANDLE



KK-H



Features

Is covered with an antibacterial coating, protecting it from contamination. (Note: black and white finishes do not have antibacterial coatings)

Parts Included

Truss head screw M4x30

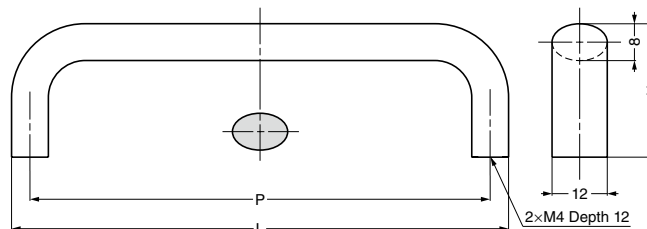

Item Code	Item Name	Material	Finish	L	H	P	Weight	Box	Carton
100-012-887	KK-H 80SNI	Aluminium Alloy	Nickel+Antibacterial Coating	78	28	70	20 g	25 pcs	200 pcs
100-012-888	KK-H 80SSG	Aluminium Alloy	Satin Gold+Antibacterial Coating	78	28	70	20 g	25 pcs	200 pcs
100-012-889	KK-H 80SBR	Aluminium Alloy	Brown+Antibacterial Coating	78	28	70	20 g	25 pcs	200 pcs
100-029-087	*KK-H 80BL	Aluminium Alloy	Paint/Black	78	28	70	20 g	25 pcs	200 pcs
100-012-890	KK-H110SNI	Aluminium Alloy	Nickel+Antibacterial Coating	108	29	100	28 g	25 pcs	200 pcs
100-012-891	KK-H110SSG	Aluminium Alloy	Satin Gold+Antibacterial Coating	108	29	100	28 g	25 pcs	200 pcs
100-012-892	KK-H110SBR	Aluminium Alloy	Brown+Antibacterial Coating	108	29	100	28 g	25 pcs	200 pcs
100-029-088	*KK-H110BL	Aluminium Alloy	Paint/Black	108	29	100	28 g	25 pcs	200 pcs
100-012-893	KK-H130SNI	Aluminium Alloy	Nickel+Antibacterial Coating	128	30	120	37 g	25 pcs	200 pcs
100-012-894	KK-H130SSG	Aluminium Alloy	Satin Gold+Antibacterial Coating	128	30	120	37 g	25 pcs	200 pcs
100-012-895	KK-H130SBR	Aluminium Alloy	Brown+Antibacterial Coating	128	30	120	37 g	25 pcs	200 pcs
100-029-089	*KK-H130BL	Aluminium Alloy	Paint/Black	128	30	120	37 g	25 pcs	200 pcs

*Without antibacterial coating.

HANDLE



KK-M



Features

Antibacterial coating keeps handle clean.

Parts Included

Truss head screw M4x30

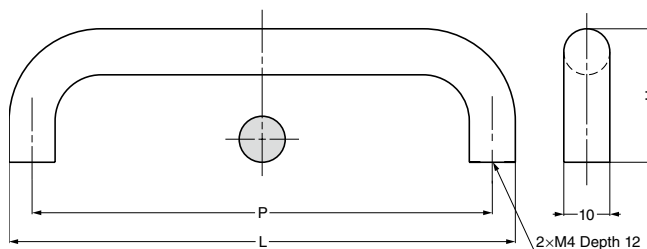

Item Code	Item Name	Material	Finish	L	H	P	Weight	Box	Carton
100-012-896	KK-M 80SNI	Aluminium Alloy	Nickel+Antibacterial Coating	80	28	70	26 g	25 pcs	200 pcs
100-012-897	KK-M 80SSG	Aluminium Alloy	Satin Gold+Antibacterial Coating	80	28	70	26 g	25 pcs	200 pcs
100-012-898	KK-M 80SBR	Aluminium Alloy	Brown+Antibacterial Coating	80	28	70	26 g	25 pcs	200 pcs
100-012-899	KK-M110SNI	Aluminium Alloy	Nickel+Antibacterial Coating	110	29	100	33 g	25 pcs	200 pcs
100-012-900	KK-M110SSG	Aluminium Alloy	Satin Gold+Antibacterial Coating	110	29	100	33 g	25 pcs	200 pcs
100-012-901	KK-M110SBR	Aluminium Alloy	Brown+Antibacterial Coating	110	29	100	33 g	25 pcs	200 pcs
100-012-902	KK-M130SNI	Aluminium Alloy	Nickel+Antibacterial Coating	130	30	120	38 g	25 pcs	200 pcs
100-012-903	KK-M130SSG	Aluminium Alloy	Satin Gold+Antibacterial Coating	130	30	120	38 g	25 pcs	200 pcs
100-012-904	KK-M130SBR	Aluminium Alloy	Brown+Antibacterial Coating	130	30	120	38 g	25 pcs	200 pcs

STAINLESS STEEL PULL



SN



Features

Black is also available. (For SN-50, SN70 and SN-95)

Parts Included

Countersunk head wood screw 3.1×20 (SUS)

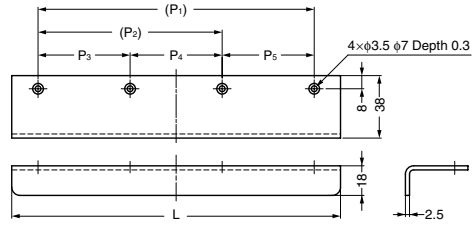

Item Code	Item Name	Material	Finish	L	P ₁	P ₂	P ₃	P ₄	P ₅	Holes	Weight	Box	Carton
100-010-162	SN-50S	Stainless Steel(SUS304)	Satin	50	-	-	30	-	-	2 pcs	47 g	40 pcs	400 pcs
100-010-155	SN-50M	Stainless Steel(SUS304)	Mirror	50	-	-	30	-	-	2 pcs	47 g	40 pcs	400 pcs
100-033-745	SN-50BL	Stainless Steel(SUS304)	Black	50	-	-	30	-	-	2 pcs	47 g	40 pcs	400 pcs
100-010-163	SN-70S	Stainless Steel(SUS304)	Satin	70	-	-	46	-	-	2 pcs	65 g	30 pcs	300 pcs
100-010-156	SN-70M	Stainless Steel(SUS304)	Mirror	70	-	-	46	-	-	2 pcs	65 g	30 pcs	300 pcs
100-033-744	SN-70BL	Stainless Steel(SUS304)	Black	70	-	-	46	-	-	2 pcs	65 g	30 pcs	300 pcs
100-010-164	SN-95S	Stainless Steel(SUS304)	Satin	95	-	-	65	-	-	2 pcs	90 g	20 pcs	200 pcs
100-010-157	SN-95M	Stainless Steel(SUS304)	Mirror	95	-	-	65	-	-	2 pcs	90 g	20 pcs	200 pcs
100-033-743	SN-95BL	Stainless Steel(SUS304)	Black	95	-	-	65	-	-	2 pcs	90 g	20 pcs	200 pcs
100-010-165	SN-120S	Stainless Steel(SUS304)	Satin	120	-	90	45	45	-	3 pcs	112 g	20 pcs	200 pcs
100-010-158	SN-120M	Stainless Steel(SUS304)	Mirror	120	-	90	45	45	-	3 pcs	112 g	20 pcs	200 pcs
100-010-166	SN-150S	Stainless Steel(SUS304)	Satin	150	-	114	57	57	-	3 pcs	147 g	15 pcs	150 pcs
100-010-159	SN-150M	Stainless Steel(SUS304)	Mirror	150	-	114	57	57	-	3 pcs	147 g	15 pcs	150 pcs
100-021-720	SN-200S	Stainless Steel(SUS304)	Satin	200	168	112	56	56	56	4 pcs	200 g	15 pcs	60 pcs
100-021-721	SN-200M	Stainless Steel(SUS304)	Mirror	200	168	112	56	56	56	4 pcs	200 g	15 pcs	60 pcs
100-021-722	SN-300S	Stainless Steel(SUS304)	Satin	300	270	180	90	90	90	4 pcs	300 g	10 pcs	40 pcs
100-021-723	SN-300M	Stainless Steel(SUS304)	Mirror	300	270	180	90	90	90	4 pcs	300 g	10 pcs	40 pcs

STAINLESS STEEL PULL



SND



Parts Included

Countersunk head wood screw 3.5×20 (SUS)

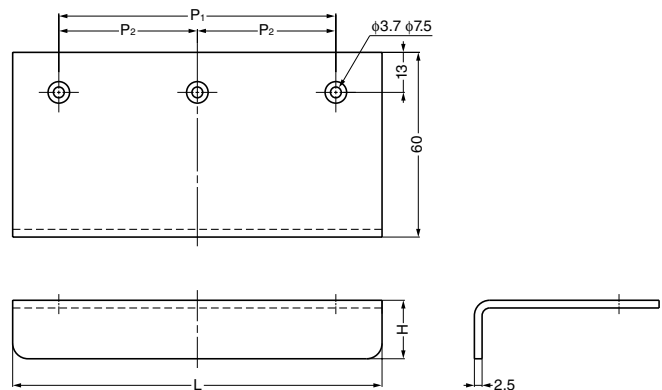

Item Code	Item Name	Material	Finish	L	H	P ₁	P ₂	Holes	Weight	Box	Carton
100-010-150	SND- 50M	Stainless Steel (SUS304)	Mirror	50	17	30	-	2 pcs	67 g	10 pcs	200 pcs
100-010-151	SND- 70M	Stainless Steel (SUS304)	Mirror	70	17	46	-	2 pcs	95 g	10 pcs	200 pcs
100-010-152	SND- 95M	Stainless Steel (SUS304)	Mirror	95	18	65	-	2 pcs	130 g	5 pcs	100 pcs
100-010-153	SND-120M	Stainless Steel (SUS304)	Mirror	120	19	90	45	3 pcs	166 g	5 pcs	50 pcs
100-010-154	SND-150M	Stainless Steel (SUS304)	Mirror	150	19	114	57	3 pcs	208 g	5 pcs	50 pcs

PULL

ANGU

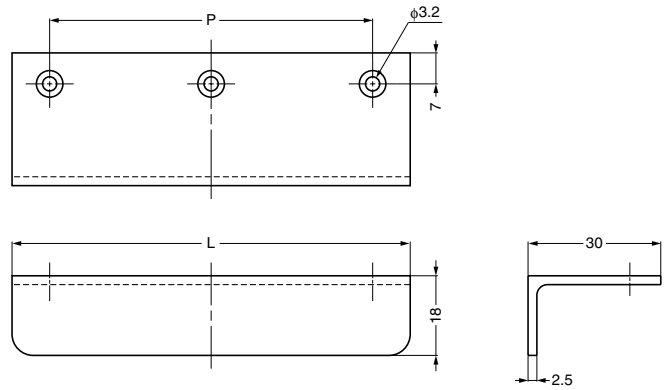

Installation

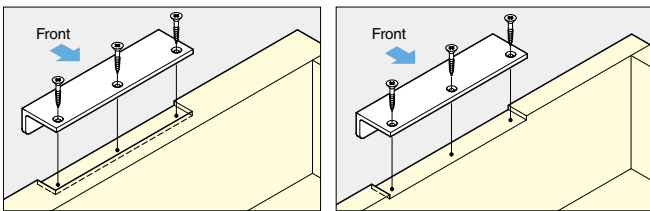

Item Code	Item Name	Material	Finish	L	P	Holes	Box	Carton
100-010-925	ANGU-A405	Brass	Satin Nickel	46	29	2 pcs	120 pcs	480 pcs
100-010-926	ANGU-A402	Brass	Satin Nickel	90	73	3 pcs	70 pcs	280 pcs

HANDLES,
PULLS & KNOBS

PULL

PULL

CHAN

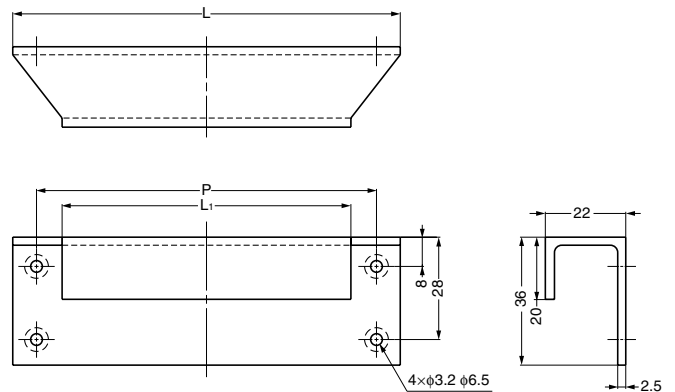

Installation

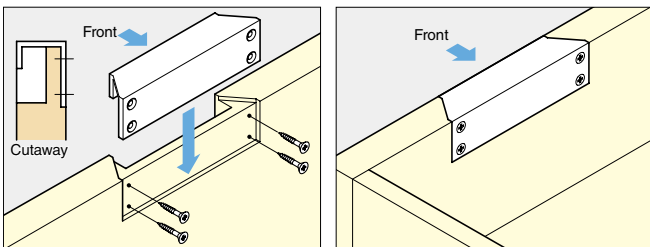

Item Code	Item Name	Material	Finish	L	L ₁	P	Box	Carton
100-010-930	CHAN-A362	Brass	Satin Nickel	106	76	93	28 pcs	112 pcs
100-010-931	CHAN-A360	Brass	Satin Nickel	137	107	123	16 pcs	64 pcs

Zwei L

Zwei L is the flagship brand of Sugatsune and represents premium Japanese hardware quality.

Zwei L stands for "Zwei Lichter" in German: a dual highlight of mirror finish and lustrous satin on a faceted profile.

Manufactured from solid billets of the finest quality 316 stainless steel, Zwei L brings the space luxury and dazzles your eyes.

Video Link



Zwei L®

Zwei L STAINLESS STEEL RECESSED PULL



ZL-2501

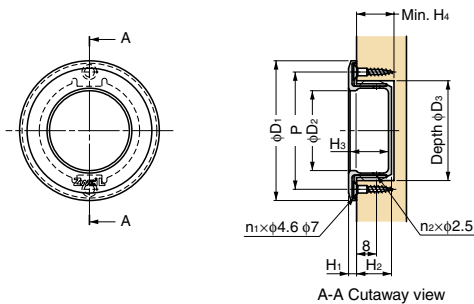

Features

- Ultrapremium Zwei L finish. Zwei L finish: Using top class polishing technology, these products combine the elegance of Satin with the deep glow of a Mirror.
- Product has an inner recessed area which can be grabbed by hand.

Parts Included

Countersunk head wood screw 3.1×16 (SUS)

Installation

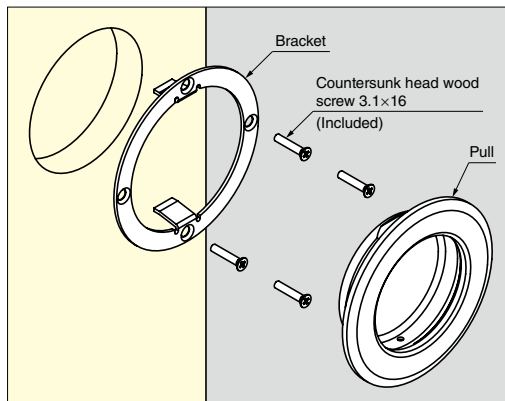

Please insert the pull after installation of the bracket with screws.

(This picture refers to ZL-2501-56)

Item Code	Item Name	Material	Finish	D ₁	D ₂	D ₃	H ₁	H ₂	H ₃	H ₄	P	n ₁	n ₂	Weight
100-011-034	ZL-2501- 56	Stainless Steel (SUS316)	Zwei L Finish	56	32	40	3.2	14	16	15	47	2	2	93 g
100-011-035	ZL-2501- 80	Stainless Steel (SUS316)	Zwei L Finish	80	50	62	4	14	16.5	15	70	4	2	196 g
100-011-036	ZL-2501-125	Stainless Steel (SUS316)	Zwei L Finish	125	80	100	5	16	20	17	112	4	4	610 g

STAINLESS STEEL RECESSED PULL



YK-70

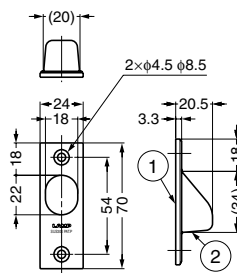

Parts Included

Countersunk head tapping screw 4x20 (SUS)

Cut Out Dimensions

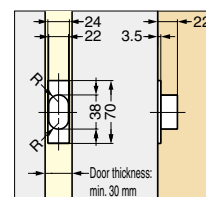

No.	Part Name	Material	Finish
①	Body	Stainless Steel (SUS304)	Satin
②	Case	Stainless Steel (SUS304)	Plain

Item Code	Item Name	Weight	Box	Carton
100-010-390	YK-70	37 g	20 pcs	200 pcs

STAINLESS STEEL RECESSED PULL



YK-W100

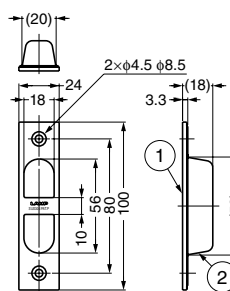

Parts Included

Countersunk head tapping screw 4x20 (SUS)

Cut Out Dimensions

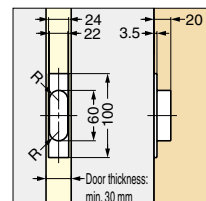

No.	Part Name	Material	Finish
①	Body	Stainless Steel (SUS304)	Satin
②	Case	Stainless Steel (SUS304)	Plain

Item Code	Item Name	Weight	Box	Carton
100-010-391	YK-W100	45 g	20 pcs	160 pcs

STAINLESS STEEL RECESSED PULL



SKH

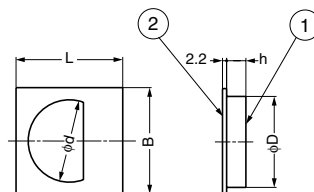

Installation

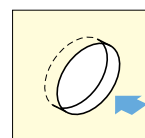

No.	Material	Finish/Colour
①	High Impact Polystyrene	Black
②	Stainless Steel (SUS304)	Satin

Item Code	Item Name	L	B	h	D	d	Weight	Box	Carton
100-010-179	SKH-44	44	44	9.8	35.1	31	10 g	100 pcs	1,000 pcs
100-010-177	SKH-47	47	47	10.3	37.6	34	11 g	60 pcs	1,440 pcs
100-010-178	SKH-57	57	57	10.3	48.6	44	16 g	50 pcs	1,200 pcs

LARGE STAINLESS STEEL RECESSED PULL



HH-M



HH-M400

Features

- Can be gripped easily even while wearing thick work gloves.
- The handlebar does not protrude outside, reducing chance for items to get caught on the bar.
- Completely stainless, available in two lengths: 200 and 400mm.

Parts Included

- Truss head screw M6×16 (SUS)
- Nut M6 (SUS)

Application Example

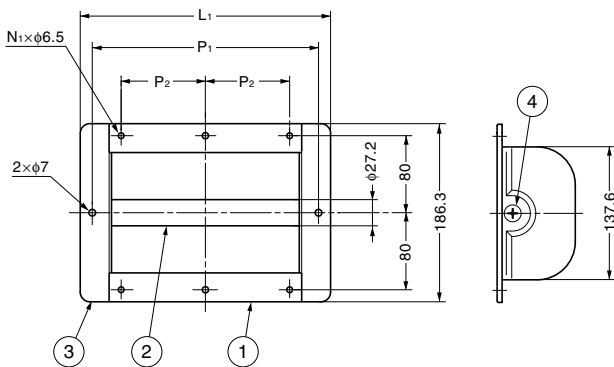
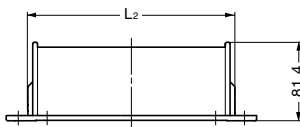
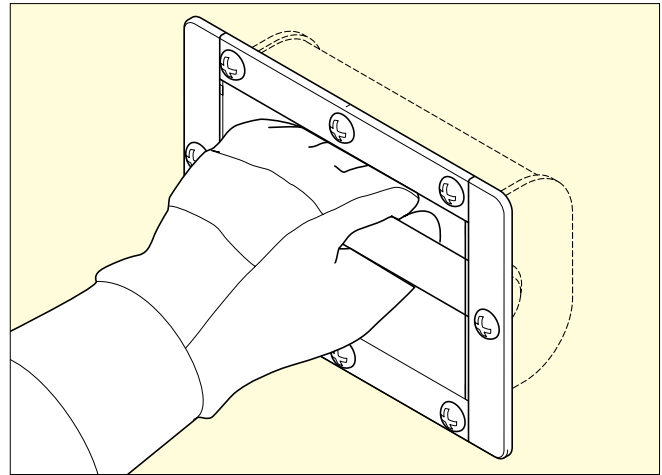
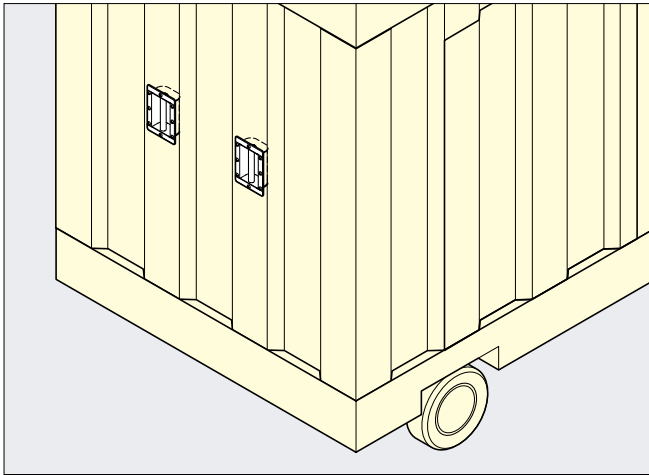

Cut Out Dimensions

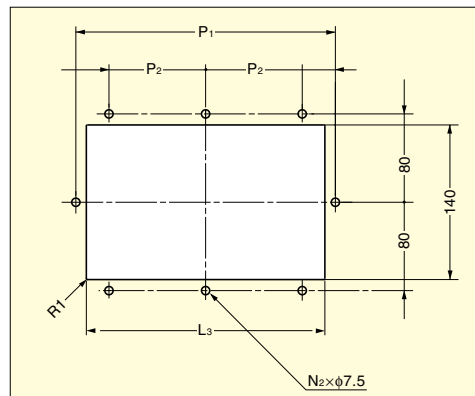

No.	Part Name	Material	Finish
①	Cup	Stainless Steel (SUS304)	Mirror
②	Bar	Stainless Steel (SUS304)	Mirror
③	Cover	Stainless Steel (SCS13)	Mirror
④	Countersunk Head Screw M8×15	Stainless Steel	-

*SCS13 is equivalent of SUS304.

Item Code	Item Name	L ₁	L ₂	L ₃	P ₁	P ₂	N ₁	N ₂	Load Capacity	Weight	Box	Carton	
100-012-306	HH-M200	260	215	218	235	87.5	6	8	4500 N	459 kgf	2.6 kg	1 pc	4 pcs
100-012-305	HH-M400	460	415	418	435	125	8	10	2200 N	224 kgf	3.7 kg	1 pc	2 pcs

RECESSED PULL WITH VENTILATOR



UTA-105



Features

- Helps prevent buildup of smells or moisture when used on lockers or cabinets.
- Ventilator is not visible from the front, providing a clean appearance.
- Made from chemically resistant resin: not easily damaged by cleaning chemicals.

Parts Included

Countersunk head tapping screw 4x20 (SUS)

Cut Out Dimensions

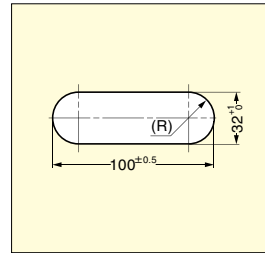

Installation

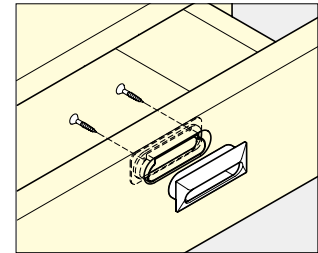

Air Flow

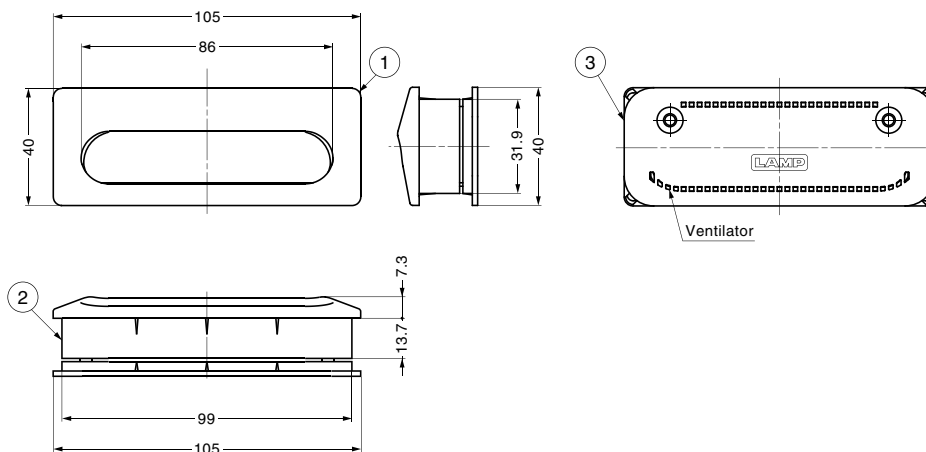
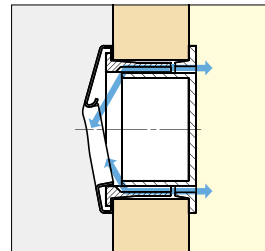

No.	Part Name	Material	Finish
①	Body	Stainless Steel (SUS304)	Satin
②	Cup	ABS	-
③	Back Cover	ABS	-

Item Code	Item Name	Colour	Max. Exhaust Area	Door Thickness	Weight	Box	Carton
100-026-733	UTA-105BL	Black	136 mm ²	18 - 25	40 g	15 pcs	150 pcs
100-026-734	UTA-105GR	Light Grey	136 mm ²	18 - 25	40 g	15 pcs	150 pcs
100-026-735	UTA-105IV	Ivory	136 mm ²	18 - 25	40 g	15 pcs	150 pcs

STAINLESS STEEL RECESSED PULL



UT



Installation

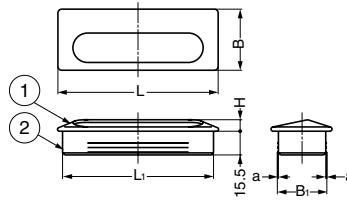
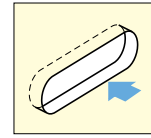

No.	Material	Finish/Colour
①	Stainless Steel (SUS304)	Satin
②	High Impact Polystyrene	Black

Item Code	Item Name	L	L ₁	H	B	B ₁	a	Weight	Box	Carton
100-010-004	UT- 75	75	71	7	36	30.8	0.4	15 g	40 pcs	400 pcs
100-010-161	UT-105	105	99	7.5	40	32.5	0.5	30 g	25 pcs	250 pcs
100-012-850	UT-140	140	134	7.5	47	40.5	0.5	45 g	15 pcs	150 pcs

STAINLESS STEEL RECESSED PULL



HH-D

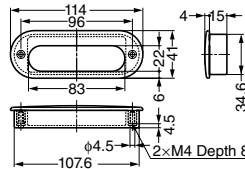

Features

Sheet metal thickness: max. 2 mm

Parts Included

- For wood panel t = 20: truss head tapping screw M4x15 (SUS)
- For sheet metal t = 2: truss head tapping screw M4x10 (SUS)

Cut Out Dimensions (For wood door)

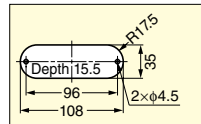

Cut Out Dimensions (For metal door)

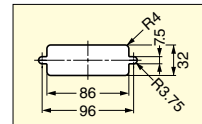

Item Code	Item Name	Material	Finish/Colour	Weight	Box	Carton
100-012-951	HH-D	Stainless Steel (SCS14)/ABS	Mirror/Black	85 g	10 pcs	60 pcs

*SCS14 is equivalent of SUS316.

STAINLESS STEEL RECESSED PULL



HH-K

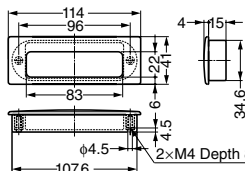

Features

Sheet metal thickness: max. 2 mm

Parts Included

- For wood panel t = 20: truss head tapping screw M4x15 (SUS)
- For sheet metal t = 2: truss head tapping screw M4x10 (SUS)

Cut Out Dimensions (For wood door)

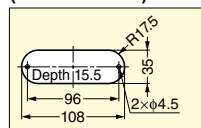

Cut Out Dimensions (For metal door)

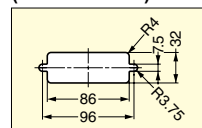

Item Code	Item Name	Material	Finish/Colour	Weight	Box	Carton
100-012-952	HH-K	Stainless Steel (SCS14)/ABS	Mirror/Black	90 g	10 pcs	60 pcs

*SCS14 is equivalent of SUS316.

STAINLESS STEEL RECESSED PULL



HH-DS114



Parts Included

- For wood panel t = 20: truss head tapping screw M4×15 (SUS)
- For sheet metal t = 2: truss head tapping screw M4×8 (SUS)

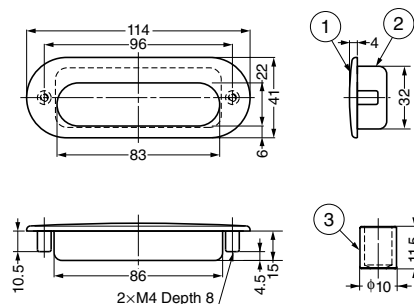

Cut Out Dimensions (For wood door)

Cut Out Dimensions (For metal door)

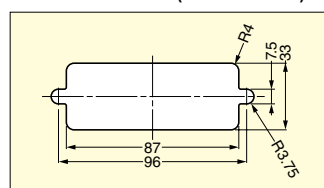
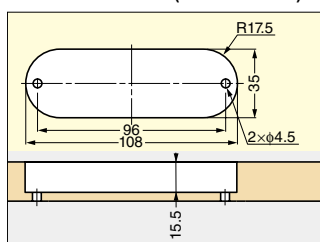

No.	Part Name	Material	Finish
①	Body	Stainless Steel (SCS14)	Mirror/Satin
②	Cup	Stainless Steel (SUS304)	Satin
③	Spacer	Stainless Steel (SUS304)	-

*SCS14 is equivalent of SUS316.

Item Code	Item Name	Finish	Weight	Box	Carton
100-010-585	HH-DS 114M	Mirror	105 g	10 pcs	60 pcs
100-010-586	HH-DS 114S	Satin	105 g	10 pcs	60 pcs

STAINLESS STEEL RECESSED PULL



HH-KS114



Parts Included

- For wood panel t = 20: truss head tapping screw M4×15 (SUS)
- For sheet metal t = 2: truss head tapping screw M4×8 (SUS)

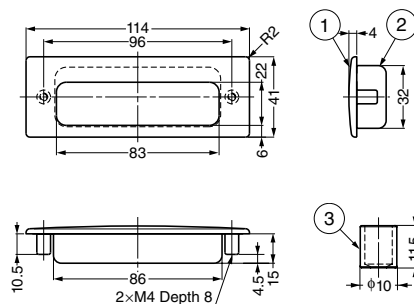

Cut Out Dimensions (For wood door)

Cut Out Dimensions (For metal door)

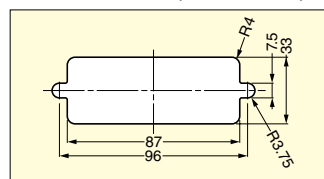
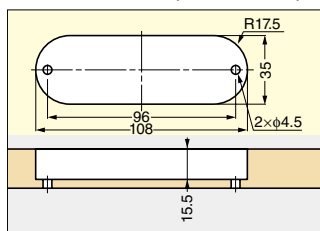

No.	Part Name	Material	Finish
①	Body	Stainless Steel (SCS14)	Mirror/Satin
②	Cup	Stainless Steel (SUS304)	Satin
③	Spacer	Stainless Steel (SUS304)	-

Item Code	Item Name	Finish	Weight	Box	Carton
100-010-583	HH-KS 114M	Mirror	110 g	10 pcs	60 pcs
100-010-584	HH-KS 114S	Satin	110 g	10 pcs	60 pcs

HANDLES,
PULLS & KNOBS

STAINLESS STEEL RECESSED PULL

STAINLESS STEEL RECESSED PULL



HH



Features

- Straightforward and simple design for easy integration.
- HH-FB-1, HH-FC-1, HH-FB-1M, HH-FC-1M are SEMI compliant (SEMIS8-0308).

Cut Out Dimensions

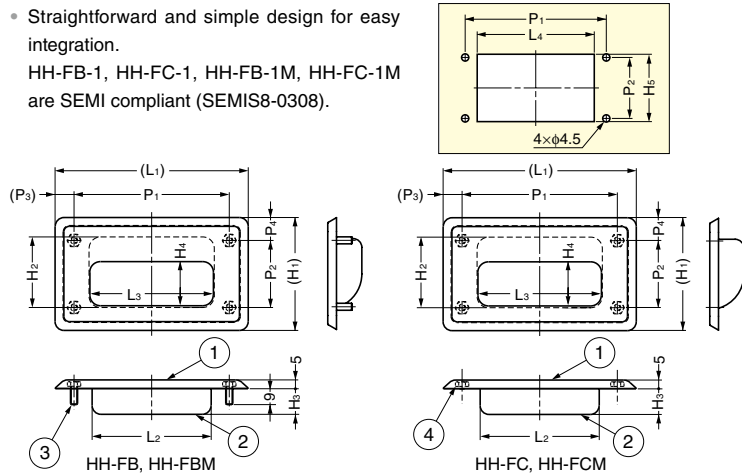

No.	Part Name	Material	Finish
①	Front Plate	Stainless Steel (SUS304)	Satin, Mirror
②	Back Cover	Stainless Steel (SUS304)	Mirror
③	M4 Stud	Stainless Steel (SUS304)	Plain
④	M4 Nut	Stainless Steel (SUS304)	Plain

Item Code	Item Name	Bolt/Nut	L ₁	L ₂	L ₃	L ₄	H ₁	H ₂	H ₃	H ₄	H ₅	P ₁	P ₂	P ₃	P ₄	Weight	Carton
100-010-090	HH-FB-1	M4 Bolt	138	96	95	99	88	62	21	35	64	110	65	14	11.5	170 g	50 pcs
100-010-091	HH-FC-1	M4 Nut	138	96	95	99	88	62	21	35	64	110	65	14	11.5	170 g	50 pcs
100-010-092	HH-FB-2	M4 Bolt	109.5	71	70	73	64	40	14.5	25	42	88	38	10.75	13	100 g	100 pcs
100-010-093	HH-FC-2	M4 Nut	109.5	71	70	73	64	40	14.5	25	42	88	38	10.75	13	100 g	100 pcs
100-010-094	HH-FB-3	M4 Bolt	94	61	60	63	60	43	12	25	45	76	32	9	14	80 g	100 pcs
100-010-095	HH-FC-3	M4 Nut	94	61	60	63	60	43	12	25	45	76	32	9	14	80 g	100 pcs
100-012-104	HH-FB-1M	M4 Bolt	138	96	95	99	88	62	21	35	64	110	65	14	11.5	170 g	50 pcs
100-012-105	HH-FC-1M	M4 Nut	138	96	95	99	88	62	21	35	64	110	65	14	11.5	170 g	50 pcs
100-012-106	HH-FB-2M	M4 Bolt	109.5	71	70	73	64	40	14.5	25	42	88	38	10.75	13	100 g	100 pcs
100-012-107	HH-FC-2M	M4 Nut	109.5	71	70	73	64	40	14.5	25	42	88	38	10.75	13	100 g	100 pcs
100-012-108	HH-FB-3M	M4 Bolt	94	61	60	63	60	43	12	25	45	76	32	9	14	80 g	100 pcs
100-012-109	HH-FC-3M	M4 Nut	94	61	60	63	60	43	12	25	45	76	32	9	14	80 g	100 pcs

STAINLESS STEEL RECESSED PULL



HH-AS2



Parts Included

M4 nut and washer

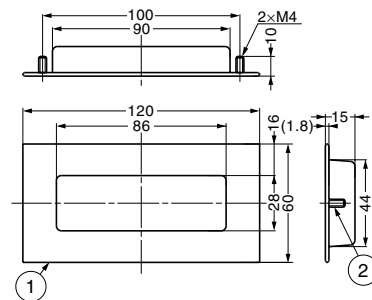

Cut Out Dimensions

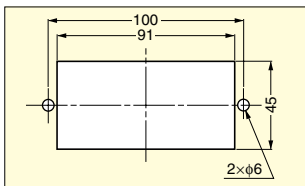

No.	Part Name	Material	Finish
①	Body	Stainless Steel (SUS304)	Satin
②	Stud bolt	Stainless Steel (SUS304)	Plain

Item Code	Item Name	Weight	Box	Carton
100-019-030	HH-AS2	50 g	12 pcs	240 pcs

RECESSED PULL



SD-160

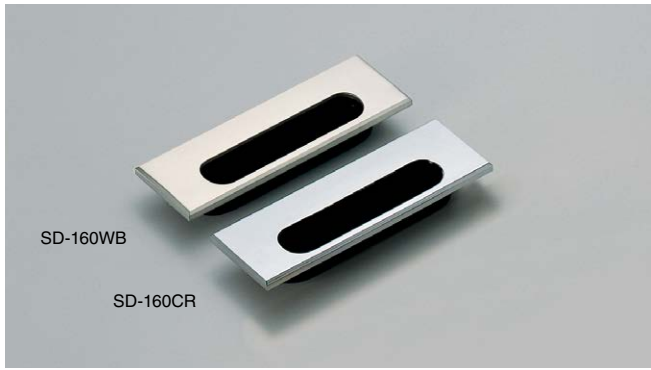

SD-160WB

SD-160CR

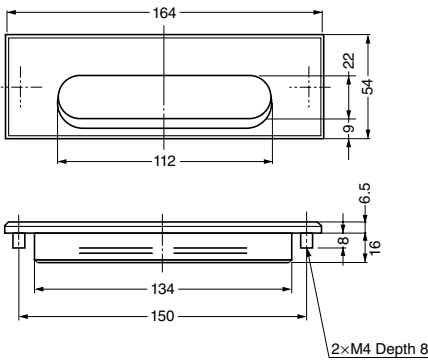

Cut Out Dimensions

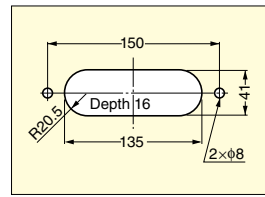

Parts Included

Truss head screw M4x8

Sold Separately
Spacer for sheet metal

Recommended Screw

Truss head screw M4x8 (For sheet metal)

Cut Out Dimensions for Wood Panel

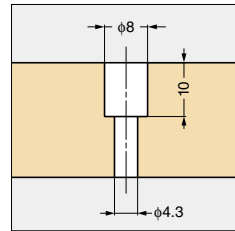

Sheet Metal Mounting Application

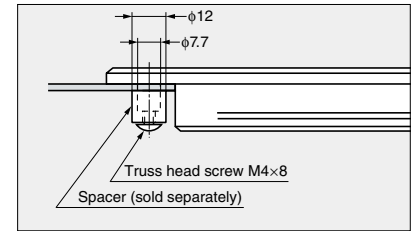

No.	Part Name	Material	Finish/Colour
①	Body	Zinc Alloy (ZDC)	WB: Satin Nickel, CR: Chrome
②	Cup	ABS	Black

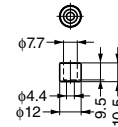

Body

Item Code	Item Name	Finish	Weight	Box	Carton
100-010-194	SD-160WB	Satin Nickel	184 g	10 pcs	60 pcs
100-010-181	SD-160CR	Chrome	184 g	10 pcs	60 pcs

Spacer (Sold Separately)

Spacer (for sheet metal)

Item Code	Item Name	Material	Finish
100-019-635	BSP-8	Steel	Yellow Zinc Chromate

RECESSED PULL



UTZ-130



UTZ-130CR

UTZ-130WB

UTZ-130SCP

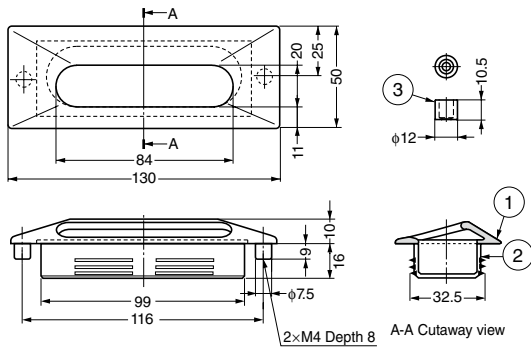

Cut Out Dimensions

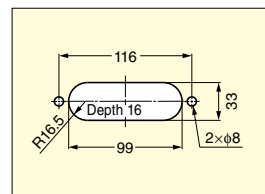

Remarks

Screws for wood panel not included.

Parts Included

- Truss head screw M4x8 (for sheet metal)
- Spacer (for sheet metal)

Cut Out Dimensions for Wood Panel

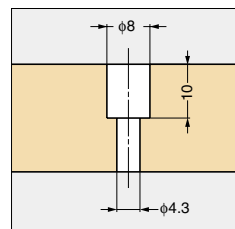

Sheet Metal Mounting Application

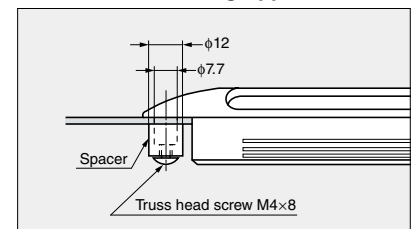

No.	Part Name	Material	Finish/Colour
①	Body	Zinc Alloy (ZDC)	Chrome, Satin Nickel, Bronze
②	Cup	Plastic (HIPS)	Black
③	Spacer	Steel	Clear Zinc Chromate

Item Code	Item Name	Finish	Weight	Box	Carton
100-010-225	UTZ-130WB	Satin Nickel	105 g	10 pcs	60 pcs
100-010-226	UTZ-130CR	Chrome	105 g	10 pcs	60 pcs
100-010-717	UTZ-130SCP	Bronze	105 g	10 pcs	60 pcs

RECESSED PULL

UP-600

Cut Out Dimensions

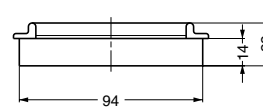
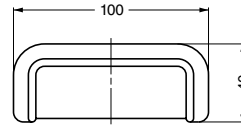
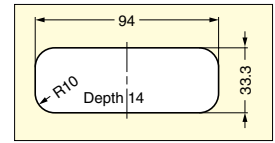

Item Code	Item Name	Material	Finish/Colour	Weight	Box	Carton
100-010-236	UP-600	ABS	Chrome, Black	25 g	50 pcs	300 pcs

RECESSED PULL



5103

Parts Included

Truss head screw M4x12

Cut Out Dimensions

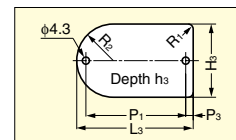

Bracket for Sheet Metal (example)

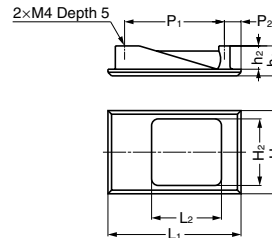
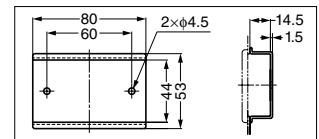

Item Code	Item Name	Material	Finish/Colour	L ₁	L ₂	H ₁	H ₂	h ₁	h ₂	P ₁	P ₂	L ₃	H ₃	P ₃	R ₁	R ₂	h ₃	Weight	Box	Carton
100-014-085	5103-55	Zinc Alloy (ZDC)	Satin Nickel	55	31.5	40	31.5	15.5	12.5	32	16	46	35	10	2	18	12.5	42 g	40 pcs	160 pcs
100-014-084	5103-80	Zinc Alloy (ZDC)	Satin Nickel	80	42	50	40	18	14	60	10	70	44	4.5	3	22	14	88 g	20 pcs	80 pcs

RECESSED PULL



HH-JS

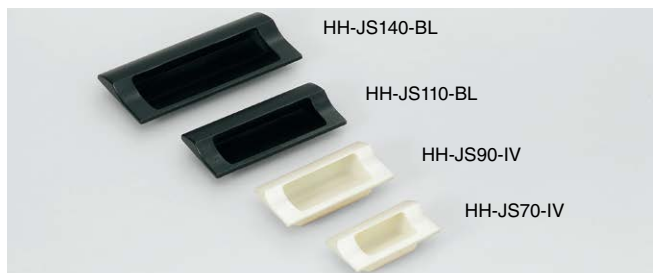

Parts Included

- Cross recessed pan head machine screw M4×10
- Spring washer 4

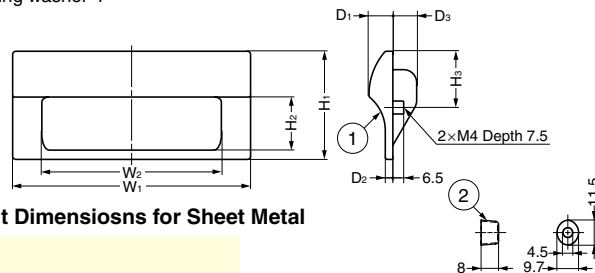

How to Install

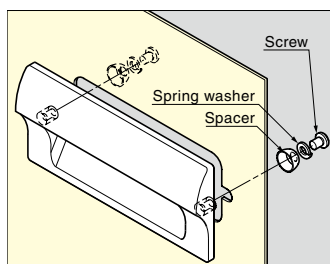

Bore Dimensions for Wood Panel

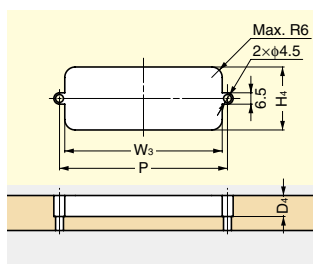

*Screws for wood panel not included.

Cut Out Dimensions for Sheet Metal

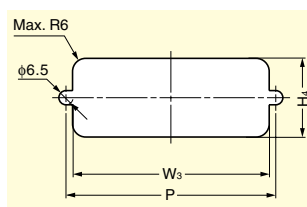

No.	Part Name	Material	Finish/Colour
①	Body	ABS + Polycarbonate (PC)	Black, Ivory
②	Spacer	Steel	Clear Zinc Chromate

Item Code	Item Name	Colour	W ₁	W ₂	H ₁	H ₂	H ₃	D ₁	D ₂	D ₃	D ₄	P	W ₃	H ₄	Door Thickness	Weight
100-024-573	HH-JS70-BL	Black	70	43	38	17	19	10.5	3	9	10	58	48	25	0.5 - 3.2	20 g
100-024-574	HH-JS70-IV	Ivory	70	43	38	17	19	10.5	3	9	10	58	48	25	0.5 - 3.2	20 g
100-024-575	HH-JS90-BL	Black	90	63	44	21.5	22	11	3	11	10	78	68	31	0.5 - 3.2	25 g
100-024-576	HH-JS90-IV	Ivory	90	63	44	21.5	22	11	3	11	10	78	68	31	0.5 - 3.2	25 g
100-024-577	HH-JS110-BL	Black	110	82	50	24.4	26	11	3.5	11	12	96	90	36	0.5 - 3.2	38 g
100-024-578	HH-JS110-IV	Ivory	110	82	50	24.4	26	11	3.5	11	12	96	90	36	0.5 - 3.2	38 g
100-024-579	HH-JS140-BL	Black	140	109	64	34	33	11.5	3.5	11	12	126	116	48	0.5 - 3.2	56 g
100-024-580	HH-JS140-IV	Ivory	140	109	64	34	33	11.5	3.5	11	12	126	116	48	0.5 - 3.2	56 g

RECESSED PULL

HH-JW

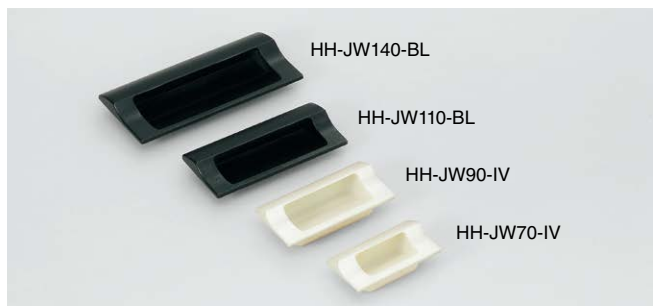

Features

- Simple one-touch installation removes the need for screws

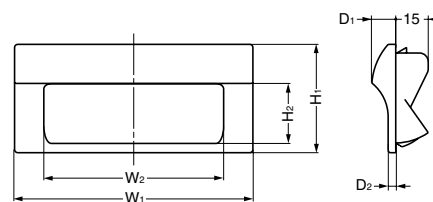

How to Install

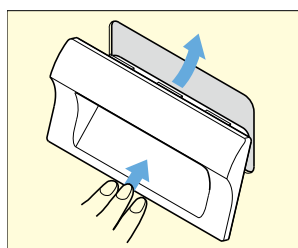

Cut Out Dimensions for Sheet Metal

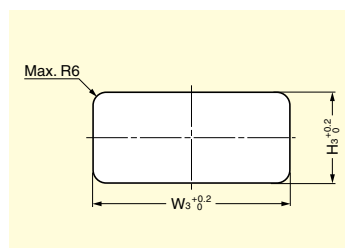

Cut Out Dimensions

Type	W ₃	H ₃			
		Board Thickness 0.8	Board Thickness 1.0 - 1.2	Board Thickness 1.5 - 2.0	Board Thickness 2.3
HH-JW70	46	28.7	29	29.4	30.8
HH-JW90	66	34.7	35	35.4	36.8
HH-JW110	88	40.7	41	41.4	42.8
HH-JW140	114	54.7	55	55.4	56.8

Item Code	Item Name	Material	Colour	W ₁	W ₂	H ₁	H ₂	D ₁	D ₂	Weight
100-024-581	HH-JW70-BL	ABS + Polycarbonate (PC)	Black	70	43	38	18.5	10.5	3	14 g
100-024-582	HH-JW70-IV	ABS + Polycarbonate (PC)	Ivory	70	43	38	18.5	10.5	3	14 g
100-024-583	HH-JW90-BL	ABS + Polycarbonate (PC)	Black	90	63	44	22.9	11	3	21 g
100-024-584	HH-JW90-IV	ABS + Polycarbonate (PC)	Ivory	90	63	44	22.9	11	3	21 g
100-024-585	HH-JW110-BL	ABS + Polycarbonate (PC)	Black	110	83	50	26.8	11.5	3.5	35 g
100-024-586	HH-JW110-IV	ABS + Polycarbonate (PC)	Ivory	110	83	50	26.8	11.5	3.5	35 g
100-024-587	HH-JW140-BL	ABS + Polycarbonate (PC)	Black	140	109	64	37.8	11.5	3.5	53 g
100-024-588	HH-JW140-IV	ABS + Polycarbonate (PC)	Ivory	140	109	64	37.8	11.5	3.5	53 g

STAINLESS STEEL RECESSED PULL

STAINLESS
304
STEEL

SMH

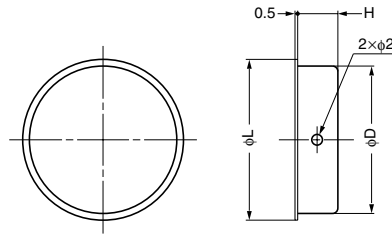

Installation

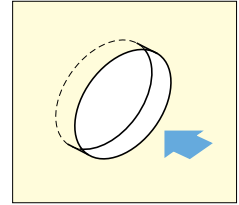

Item Code	Item Name	Material	Finish	L	H	D	Weight	Box	Carton
100-010-184	SMH-30	Stainless Steel (SUS304)	Satin	30	7.5	27.5	4 g	100 pcs	3,600 pcs
100-010-185	SMH-37	Stainless Steel (SUS304)	Satin	36	8.5	31.5	6 g	100 pcs	3,600 pcs
100-010-186	SMH-45	Stainless Steel (SUS304)	Satin	46	8.5	41	9.5 g	100 pcs	2,400 pcs
100-010-187	SMH-60	Stainless Steel (SUS304)	Satin	60	9.5	53.5	15 g	50 pcs	1,200 pcs
100-010-188	SMH-80	Stainless Steel (SUS304)	Satin	80	9.5	71	25.5 g	25 pcs	500 pcs

STAINLESS STEEL RECESSED PULL

STAINLESS
304
STEEL

OP-150

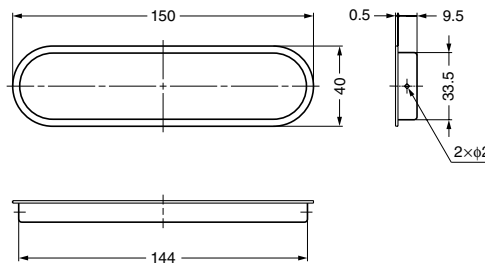

Installation

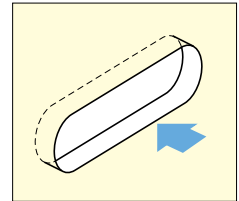

Item Code	Item Name	Material	Finish	Weight	Box	Carton
100-015-016	OP-150	Stainless Steel (SUS304)	Satin	30 g	30 pcs	720 pcs

STAINLESS STEEL RECESSED PULL

STAINLESS
304
STEEL

HN



Parts Included

φ1.2×10 nail (SUS)

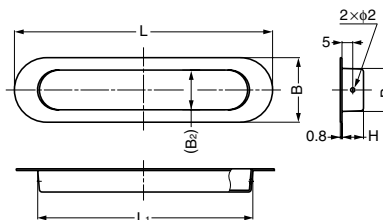

Cut Out Dimensions

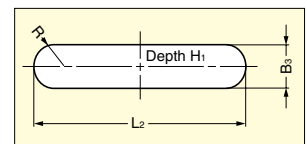

Item Code	Item Name	Material	Finish	L	L ₁	H	B	B ₁	B ₂	L ₂	B ₃	H ₁	Weight	Box	Carton
100-012-953	HN-120SH	Stainless Steel (SUS304)	Satin	120	100	10	30	20	18.5	100.5	20.5	10.5	19 g	50 pcs	500 pcs
100-012-954	HN-150SH	Stainless Steel (SUS304)	Satin	150	130	12	35	26	24.5	130.5	26.5	12.5	27 g	20 pcs	200 pcs
100-012-955	HN-200SH	Stainless Steel (SUS304)	Satin	200	170	13.2	50	36	34.5	170.5	36.5	13.7	50 g	10 pcs	100 pcs
100-012-956	HN-250SH	Stainless Steel (SUS304)	Satin	250	220	13.2	50	36	34.5	220.5	36.5	13.7	92 g	10 pcs	100 pcs

RECESSED PULL



XLA-HHA



Features

- Long recessed handle available in two sizes: 300 and 600mm.
- Length can be freely changed by cutting the handle to the appropriate length.
- Straight linear design provides a visually appealing design that integrates very easily.
- Custom sizes are available, please contact us for details.

Parts Included

Truss head screw M4x10 (SUS)

Sold Separately

Bracket for sheet metal XLA-HHA40B

Cut Out Dimensions (For Wood)

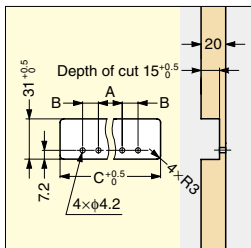

Sheet Metal Mounting Application

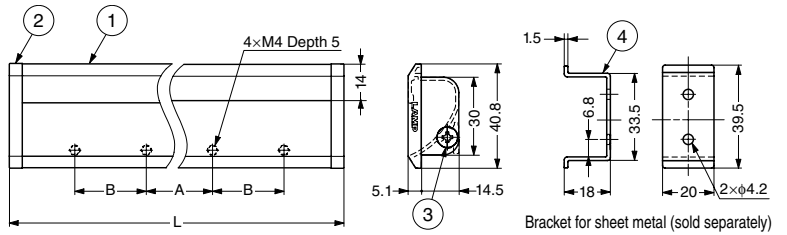
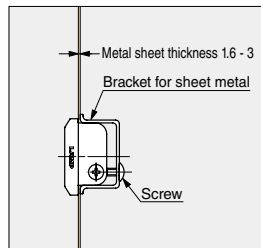

No.	Part Name	Material	Finish
①	Body	Aluminium Alloy	Silver Anodized
②	Cover	Zinc Alloy (ZDC)	Chrome
③	Screw	Stainless Steel	-
④	Bracket (Option)	Stainless Steel (SUS430)	Polished

Body

Item Code	Item Name	L	A	B	C	Weight	Box
100-010-190	XLA-HHA300	300	100	50	297	140 g	100 pcs
100-010-191	XLA-HHA600	600	200	150	597	245 g	50 pcs

Bracket for Sheet Metal (Sold Separately)

Item Code	Item Name
100-010-189	XLA-HHA40B

RECESSED PULL W/ TOGGLE FINGER PROTECTOR



HH-P135

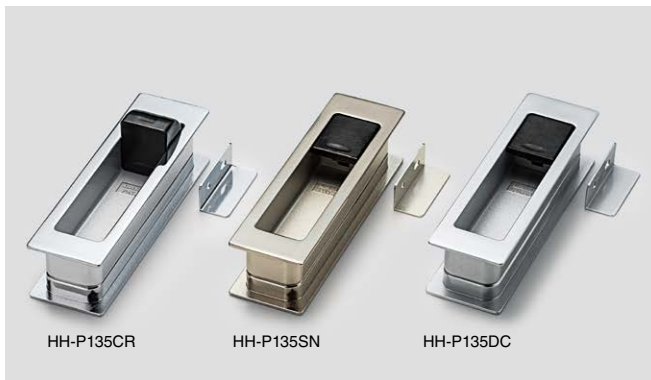

Features

- Recessed pull with finger protector. Finger protector can be toggled on and off. When it is toggled on, the pull protects fingers from being caught inside the pull's recessed area while closing sliding doors.
- When people in wheelchairs are passing, the switch can be toggled off, allowing the sliding door to fully open. This supports barrier-free design.
- Can be used on doors that are between 40-50mm thick. (Requires longer screws)

Remarks

In case using with counter plate, set the gap (*) 7 mm.

Parts Included

Countersunk head screw M4x25

Cut Out Dimensions

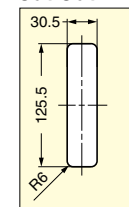
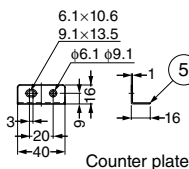
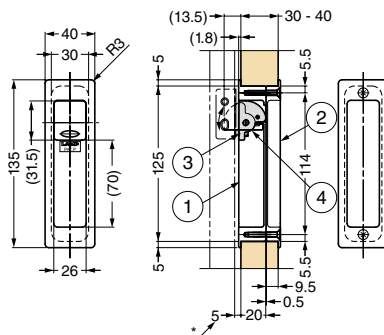
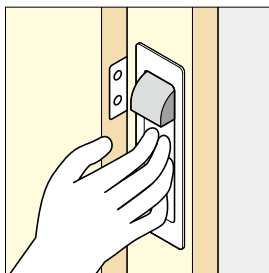

No.	Part Name	Material	Finish/Colour
①	Pull A	Zinc Alloy (ZDC)	Satin Nickel, Chrome, Dull Chrome
②	Pull B		
③	Protector	Polyurethane (PUR)	Black
④	Shaft	Stainless Steel (SUS304)	Plain
⑤	Strike Plate	Steel (SPCC)	Satin Nickel, Chrome, Dull Chrome

Item Code	Item Name	Finish	Door Thickness	Weight	Box	Carton
100-010-096	HH-P135SN	Satin Nickel	30 - 40	290 g	5 pcs	50 pcs
100-010-097	HH-P135CR	Chrome	30 - 40	290 g	5 pcs	50 pcs
100-010-098	HH-P135DC	Dull Chrome	30 - 40	290 g	5 pcs	50 pcs

STAINLESS STEEL HATCH PULL



ST-90, ST-115



Application Example

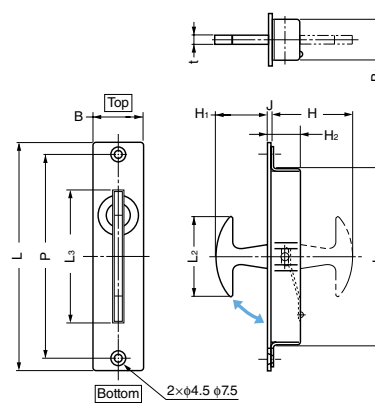
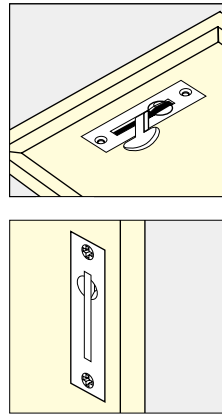

Features

- Can be used vertically, on the ceiling or on the ground. Has a wide variety of potential applications.
- Uses a built in spring to hold in place, protecting it from unintentional movements from vibrations.

Parts Included

Countersunk head wood screw (SUS)

Item Code	Item Name	Material	Finish	L	L ₁	L ₂	L ₃	H	H ₁	H ₂	J	B	B ₁	t	P	Screw	Weight	Box	Carton
100-010-240	ST- 90	Stainless Steel (SUS304)	Satin	90	66.2	30.2	57	35.5	23.2	10.5	2.2	22	18.5	3.8	80	3.5x22	68 g	30 pcs	300 pcs
100-010-241	ST-115	Stainless Steel (SUS304)	Satin	115	86.2	40	67	42	26	13	2.5	25	20	4	102	3.5x25	102 g	20 pcs	200 pcs

STAINLESS STEEL HATCH PULL



ST-80, ST-100

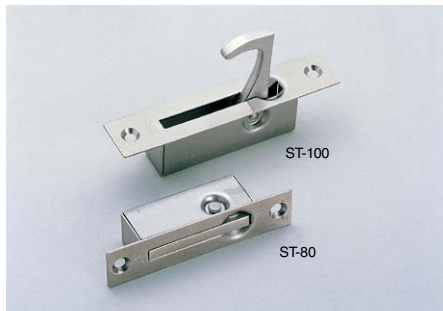

Application Example

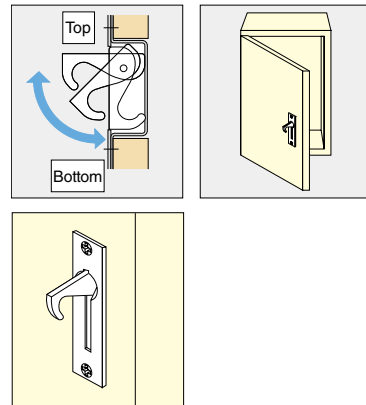

Parts Included

Countersunk head wood screw (SUS)

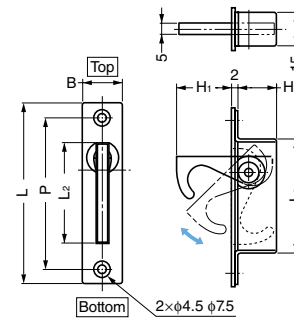

Item Code	Item Name	Material	Finish	L	L ₁	L ₂	H	H ₁	B	P	Screw	Weight	Box	Carton
100-010-244	ST- 80	Stainless Steel (SUS304)	Satin	80	50	44	18	25	18	68	3.5x16	48 g	30 pcs	300 pcs
100-010-245	ST-100	Stainless Steel (SUS304)	Satin	100	63	54	21	32	20	85	3.5x20	66 g	20 pcs	200 pcs

RECESSED LEVER PULL



FH-100AK, FH-100BK

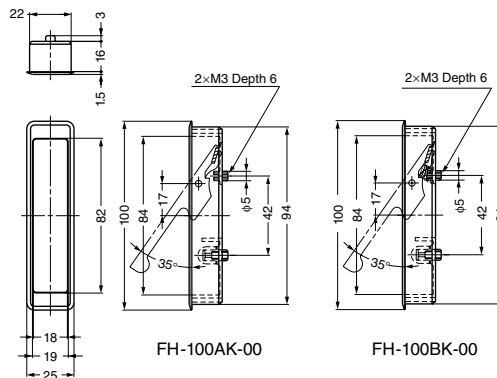

Features

- FH-100AK (Stay type) will stay open even after the fingers are not longer holding the lever.
- FH-100BK (Return type) will automatically close after fingers are not holding the lever.
- Recommended for doors over 25mm thick.
- When installing on sheet metal, please prepare a separate bracket for sheet metal.

Parts Included

Truss head screw M3x12

Cut Out Dimensions

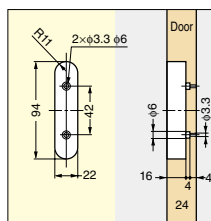

Bracket for Sheet Metal (example)

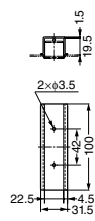

Item Code	Item Name	Material	Finish		Weight	Box	Carton
			Body	Handle			
100-010-251	FH-100AK-00	Zinc Alloy (ZDC)	Nickel	Satin Nickel	105 g	12 pcs	72 pcs
100-010-252	FH-100BK-00	Zinc Alloy (ZDC)	Nickel	Satin Nickel	105 g	12 pcs	72 pcs

STAINLESS STEEL HATCH PULL



HR

Parts Included

- HR-90S: Countersunk head wood screw 3.5x22 (SUS)
- HR-110S & HR-135S: Countersunk head wood screw 3.5x25 (SUS)

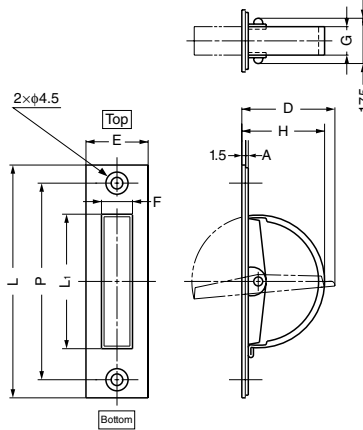

Item Code	Item Name	Material	Finish	L	L ₁	P	H	D	A	E	F	G	Load Capacity	Weight	Box	Carton	
100-012-614	HR- 90S	Stainless Steel (SUS304)	Satin	90	52	76	32	36	1	24	12	11	127 N	13 kgf	49 g	30 pcs	300 pcs
100-012-615	HR-110S	Stainless Steel (SUS304)	Satin	110	64	94	38	42	1	24	12	11	98 N	10 kgf	59 g	20 pcs	200 pcs
100-012-817	HR-135S	Stainless Steel (SUS304)	Satin	135	90	115	50	55	1.2	25	12.2	12	74 N	7.5 kgf	88 g	15 pcs	150 pcs

STAINLESS STEEL HATCH PULL



HR-RS

Parts Included

- Countersunk head wood screw 3.5x22 (SUS)

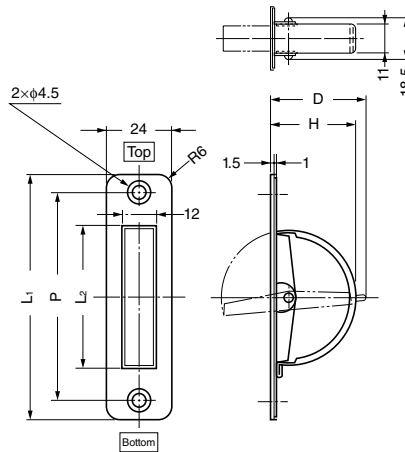

Item Code	Item Name	Material	Finish	L ₁	L ₂	P	H	D	Load Capacity	Weight	Box	Carton	
100-019-058	HR- 90RS	Stainless Steel (SUS304)	Satin	90	52	76	32	36	127 N	13 kgf	46 g	30 pcs	300 pcs
100-019-059	HR-110RS	Stainless Steel (SUS304)	Satin	110	64	94	38	42	98 N	10 kgf	55 g	20 pcs	200 pcs

RECESSED LEVER PULL



FH-100AM, FH-100BM

Features

- FH-100AM (Stay type) will stay open after fingers are no longer holding the lever.
- FH-100BM (Return type) will automatically close after fingers are not holding the lever.
- Recommended for doors over 25mm thick.
- When installing on sheet metal, please prepare a separate bracket for sheet metal.

Parts Included

- Truss head screw M3x14

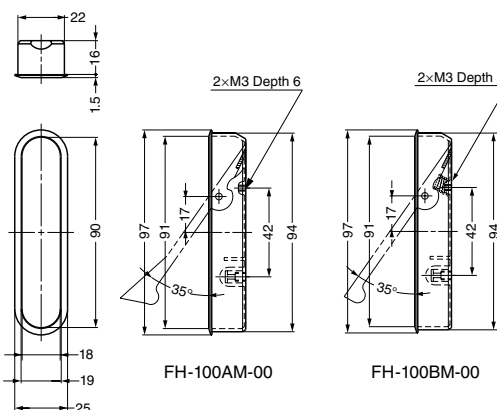

Cut Out Dimensions

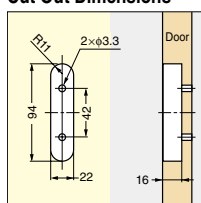

Bracket for Sheet Metal (example)

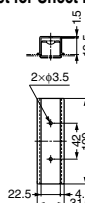

Item Code	Item Name	Material	Finish		Weight	Box	Carton
			Body	Handle			
100-010-444	FH-100AM-00	Zinc Alloy (ZDC)	Nickel	Satin Nickel	103.5 g	12 pcs	72 pcs
100-010-445	FH-100BM-00	Zinc Alloy (ZDC)	Nickel	Satin Nickel	103.5 g	12 pcs	72 pcs

STAINLESS STEEL RING PULL

26900

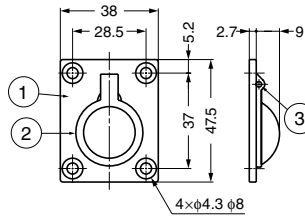

Recommended Screw
Countersunk head tapping screw 3.5
Cut Out Dimensions

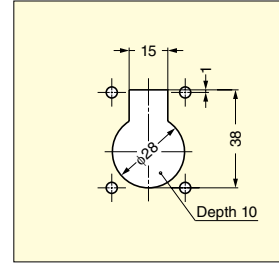

No.	Part Name	Material	Finish/Colour
①	Body	Stainless Steel (SCS14)	Mirror
②	Handle		
③	Pin	Stainless Steel (SUS304)	Plain

Item Code	Item Name	Material	Finish	Weight(g)	Box(pcs)	Carton(pcs)
100-096-009	26900	Stainless Steel (SCS14)	Mirror	45	20	100

*SCS14 is equivalent of SUS316.

STAINLESS STEEL RING PULL

26901

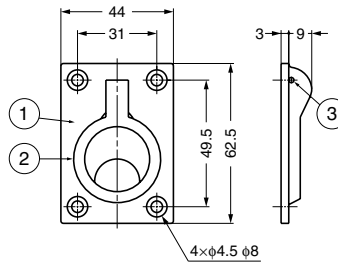

Recommended Screw
Countersunk head tapping screw 3.5
Cut Out Dimensions

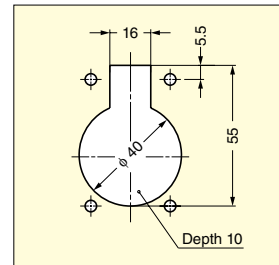

No.	Part Name	Material	Finish/Colour
①	Body	Stainless Steel (SCS14)	Mirror
②	Handle		
③	Pin	Stainless Steel (SUS304)	Plain

Item Code	Item Name	Material	Finish	Weight(g)	Box(pcs)	Carton(pcs)
100-096-010	26901	Stainless Steel (SCS14)	Mirror	85	20	100

*SCS14 is equivalent of SUS316.

STAINLESS STEEL RING PULL

26700

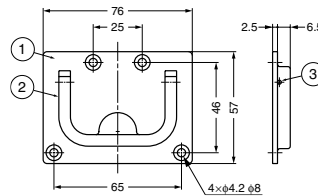

Recommended Screw
Countersunk head tapping screw 3.5
Cut Out Dimensions

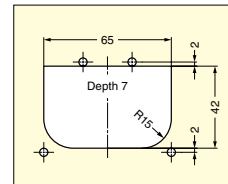

No.	Part Name	Material	Finish/Colour
①	Body	Stainless Steel (SCS14)	Mirror
②	Handle		
③	Pin	Stainless Steel (SCS14), Stainless Steel (SUS304)	Plain

Item Code	Item Name	Material	Finish	Weight(g)	Box(pcs)	Carton(pcs)
100-096-011	26700	Body and Handle: Stainless Steel SCS14 pin: Stainless Steel SUS14	Mirror	120	10	100
100-043-251	26700-1	All Stainless Steel SCS14		-		

*SCS14 is equivalent of SUS316.

STAINLESS STEEL RING PULL



Features

Spring powered to automatically close when hands are removed.

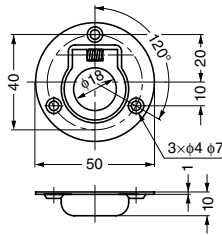

Cut Out Dimensions

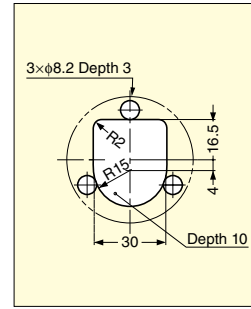

Parts Included

Tapping screw 3x16 (SUS)

For Sheet Metal

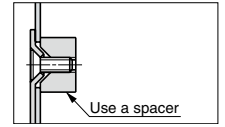

980640

HANDLES, PULLS & KNOBS

Item Code	Item Name	Material	Finish	Load Capacity	Weight	Box
100-011-740	980640	Stainless Steel (SUS304)	Mirror	196 N / 20 kgf	23 g	10 pcs

STAINLESS STEEL RING PULL



Features

Spring powered to automatically close when hands are removed.

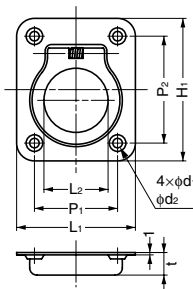

Cut Out Dimensions

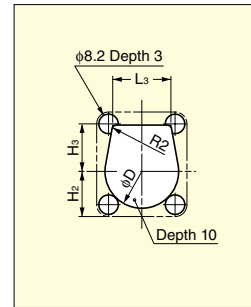

Parts Included

- 980641:
Tapping screw 3x16 (SUS)
- 980642:
Tapping screw 3.5x16 (SUS)

For Sheet Metal

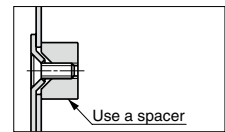

980641, 980642

STAINLESS STEEL RING PULL

Item Code	Item Name	Material	Finish	L ₁	L ₂	L ₃	H ₁	H ₂	H ₃	D	t	P ₁	P ₂	d ₁	d ₂	Load Capacity	Weight	Box
100-011-737	980641	Stainless Steel (SUS304)	Mirror	38	18	24.5	44	19	19.5	31	10	28	34	4	6.2	196 N / 20 kgf	21 g	10 pcs
100-011-738	980642	Stainless Steel (SUS304)	Mirror	50	27	25	60	25	25	41	9.5	35	45	4.4	7	245 N / 25 kgf	36 g	10 pcs

STAINLESS STEEL RING PULL



Features

Spring powered to automatically close when hands are removed.

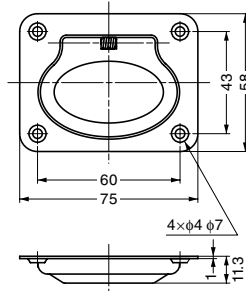

Cut Out Dimensions

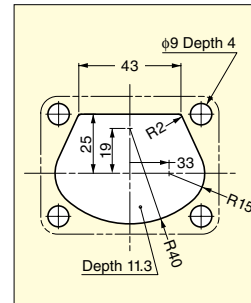

Parts Included

Tapping screw 3.5x16 (SUS)

For Sheet Metal

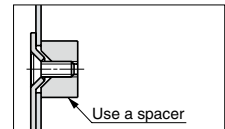

980643

Item Code	Item Name	Material	Finish	Load Capacity	Weight	Box
100-011-739	980643	Stainless Steel (SUS304)	Mirror	245 N / 25 kgf	51 g	10 pcs

BRASS RING PULL



587



Parts Included
M4x25 truss head screw

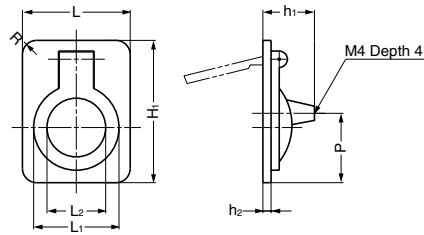

Cut Out Dimensions

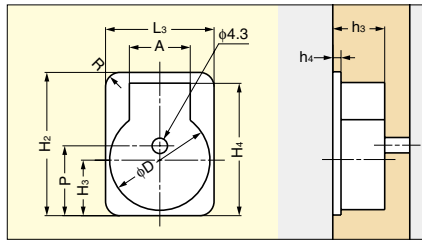

Item Code	Item Name	Material	Finish	L	L ₁	L ₂	H ₁	h ₁	h ₂	P	L ₃	H ₂	H ₃	H ₄	A	D	h ₃	h ₄	R	Weight	Box
100-016-010	587-40WB	Brass	Satin Nickel	30.5	24	16.5	40.3	13.6	2	20.6	30.5	40.3	16	39	18	28	15	2	4	40 g	100 pcs
100-016-011	587-40SB	Brass	Satin	30.5	24	16.5	40.3	13.6	2	20.6	30.5	40.3	16	39	18	28	15	2	4	40 g	100 pcs
100-016-014	587-50WB	Brass	Satin Nickel	38	30.5	21	51	14	2.5	25.5	38	51	21	48.5	21	35	15	2.5	6	59 g	50 pcs
100-016-015	587-50SB	Brass	Satin	38	30.5	21	51	14	2.5	25.5	38	51	21	48.5	21	35	15	2.5	6	59 g	50 pcs
100-016-018	587-60WB	Brass	Satin Nickel	47.5	36	24.5	60	15.5	2.5	30	47.5	60	23.5	55	21	41.5	16.5	2.5	6.5	86 g	50 pcs
100-016-019	587-60SB	Brass	Satin	47.5	36	24.5	60	15.5	2.5	30	47.5	60	23.5	55	21	41.5	16.5	2.5	6.5	86 g	50 pcs

BRASS RING PULL



587B



Parts Included
Slotted countersunk head wood screw 3.1x20

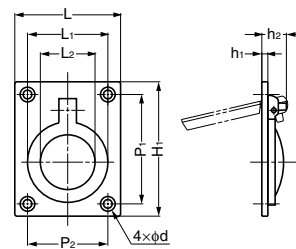

Cut Out Dimensions

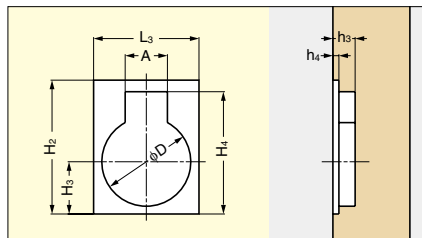

Item Code	Item Name	Material	Finish	L	L ₁	L ₂	H ₁	P ₁	P ₂	P ₃	d	h ₁	h ₂	L ₃	H ₂	H ₃	H ₄	H ₅	A	D	h ₃	h ₄	Weight	Box
100-016-012	587B-40WB	Brass	Satin Nickel	30.5	24	16.5	40.3	32	22	11.85	3.5	2	11	30.5	40.3	16	39	32	18	28	13	2	28 g	100 pcs
100-016-013	587B-40SB	Brass	Satin	30.5	24	16.5	40.3	32	22	11.85	3.5	2	11	30.5	40.3	16	39	32	18	28	13	2	28 g	100 pcs
100-016-016	587B-50WB	Brass	Satin Nickel	38	30.5	21	51	41	28	15.5	4	2.5	12.7	38	51	21	48.5	41	21	35	15	2.5	54 g	50 pcs
100-016-017	587B-50SB	Brass	Satin	38	30.5	21	51	41	28	15.5	4	2.5	12.7	38	51	21	48.5	41	21	35	15	2.5	54 g	50 pcs
100-016-020	587B-60WB	Brass	Satin Nickel	47.5	36	24.5	60	49	36	18	4	2.5	13	47.5	60	23.5	55	49	21	41.5	14	2.5	80 g	50 pcs
100-016-021	587B-60SB	Brass	Satin	47.5	36	24.5	60	49	36	18	4	2.5	13	47.5	60	23.5	55	49	21	41.5	14	2.5	80 g	50 pcs

BRASS RING PULL



580



Parts Included
M4x25 truss head screw

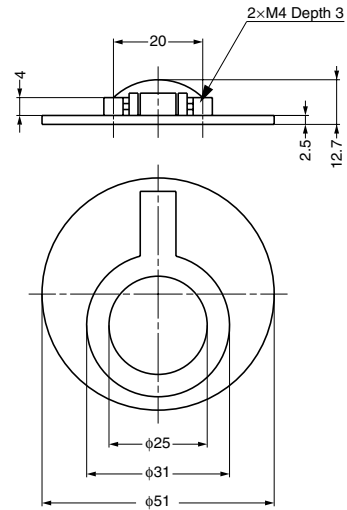

Cut Out Dimensions

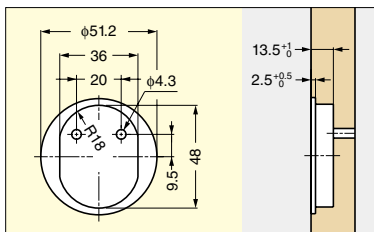

Item Code	Item Name	Material	Finish	Weight	Box
100-016-025	580-WB	Brass	Satin Nickel	62 g	50 pcs
100-016-026	580-SB	Brass	Satin	62 g	50 pcs

HANDLES,
PULLS & KNOBS

RING PULL / HANDLE

VINYL HANDLE

PS



Features

- Handle can be pulled out when in use.

Recommended Screw

Countersunk head wood screw 5.5

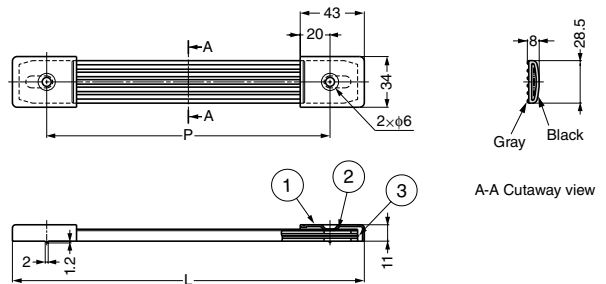

No.	Part Name	Material	Finish/Colour
①	Cover	Steel	Black
②	Handle	PVC	Grey/Black
③	Reinforcing Plate	Steel	Yellow Zinc Chromate

Item Code	Item Name	L	P	Weight	Box
100-010-249	PS-190	236	190	100 g	50 pcs
100-010-250	PS-220	266	220	110 g	50 pcs



STAINLESS STEEL TRUNK HANDLE



HCT-150



Features

- Spring powered to automatically close when hands are removed.

Parts Included

- M5x12 truss head screw (SUS)
- Bracket for sheet metal (SUS)

Cut Out Dimensions

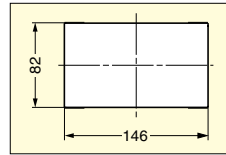

Sheet Metal Mounting Application

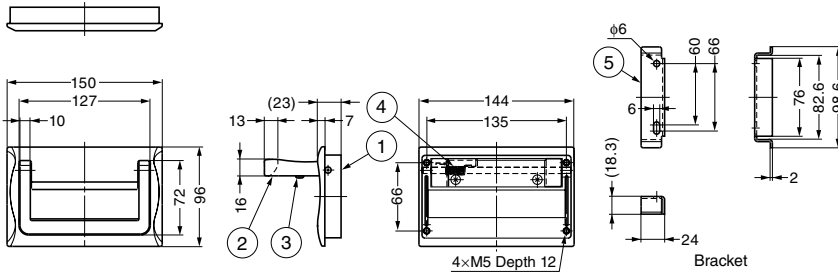
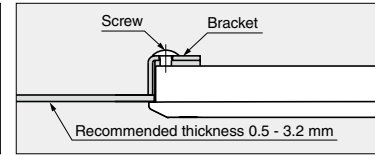

No.	Part Name	Material	Finish/Colour
①	Body	Stainless Steel (SCS14)	Mirror
②	Handle	Stainless Steel (SCS14)	Mirror
③	Bumper	Ethylene Propylene Rubber (EPDM)	Black
④	Spring	Stainless Steel (SUS316)	-
⑤	Bracket for Sheet Metal	Stainless Steel (SUS316)	Mirror

*SCS14 is equivalent of SUS316.

Item Code	Item Name	Load Capacity		Weight	Box	Carton
100-017-557	HCT-150	980 N	100 kgf	990 g	5 pcs	20 pcs

TRUNK HANDLE



TMU-115



Features

- Can be front or back mounted.
- Spring powered to automatically close when hands are removed.
- A smaller type (TMU-100) is also available. Please contact us for details.

Parts Included

- For back mount: M5x6 truss head screw
- For surface mount: Countersunk head wood screw 4.8x25 and 4.8x20

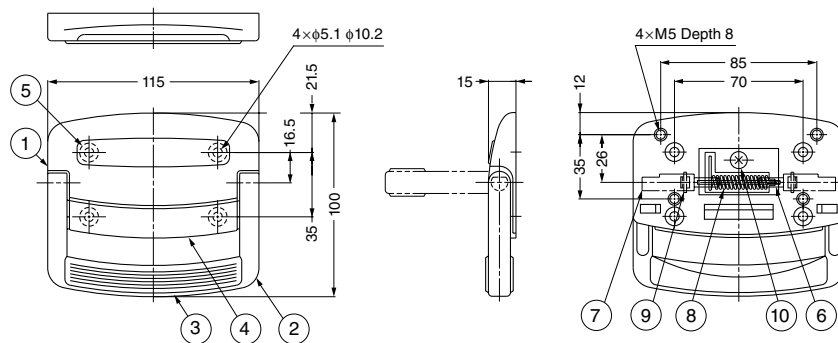

No.	Part Name	Material	Finish/Colour
①	Body	Zinc Alloy (ZDC)	Chrome
②	Handle	Zinc Alloy (ZDC)	Chrome
③	Grip	Elastomer (TPE)	Black
④	Case Cover 1	Elastomer (TPE)	Black
⑤	Case Cover 2	Elastomer (TPE)	Black
⑥	Back Cover	Steel	Yellow Zinc Chromate
⑦	Shaft	Zinc Alloy (ZDC)	Nickel
⑧	Spring	Steel	Yellow Zinc Chromate
⑨	Pivot Ring	-	5103-31
⑩	Screw	Steel	Yellow Zinc Chromate

Item Code	Item Name	Load Capacity		Weight	Box	Carton
100-901-273	TMU-115	392 N	40 kgf	460 g	10 pcs	40 pcs

TRUNK HANDLE

TEST METHOD 1



MUD-140



Features

- Spring powered to automatically close when hands are removed.

Parts Included

M5x8 truss head screw

Cut Out Dimensions

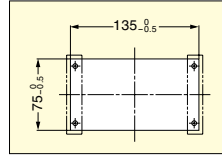

Mounting Application

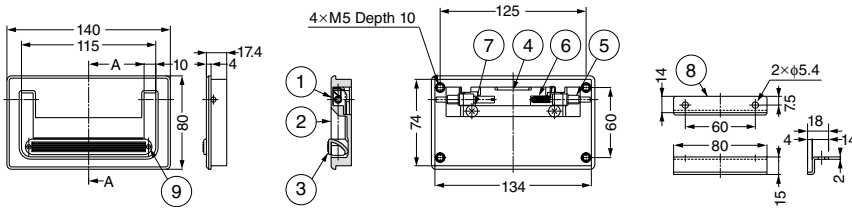
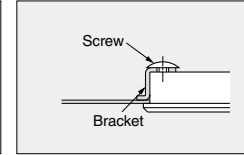

No.	Part Name	Material	Finish/Colour
①	Body	Zinc Alloy (ZDC)	Chrome
②	Handle	Zinc Alloy (ZDC)	Chrome
③	Grip	Elastomer (TPE)	Black
④	Back Cover	Steel	Yellow Zinc Chromate
⑤	Shaft	Zinc Alloy (ZDC)	Yellow Zinc Chromate
⑥	Spring	Steel	Yellow Zinc Chromate
⑦	Screw	Steel	-
⑧	Bracket	Steel	Yellow Zinc Chromate
⑨	Screw	Stainless Steel	Black

Item Code	Item Name	Load Capacity	Weight	Box	Carton	
100-901-272	MUD-140	294 N	30 kgf	620 g	5 pcs	20 pcs

TRUNK HANDLE

TEST METHOD 1

PT-148



Features

- Spring powered to automatically close when hands are removed.

Cut Out Dimensions

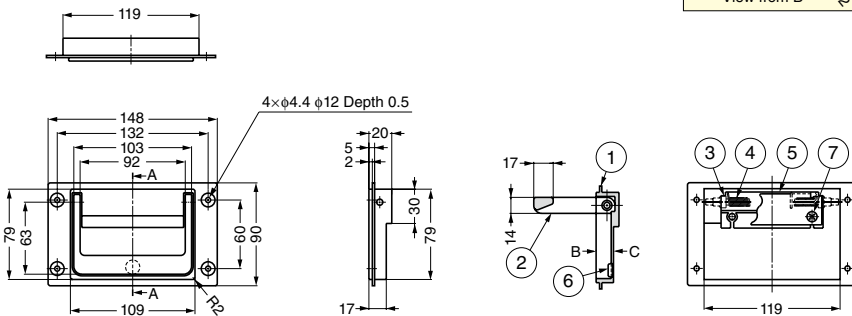
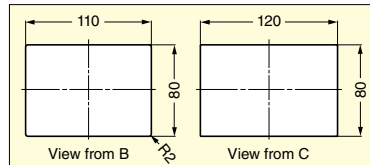

No.	Part Name	Material	Finish/Colour
①	Body	Zinc Alloy (ZDC)	Grey
②	Handle	Zinc Alloy (ZDC)	Grey
③	Shaft	Steel	Plain
④	Spring	Steel	Clear Zinc Chromate
⑤	Back Cover	Steel	Yellow Zinc Chromate
⑥	Bumper	Polyurethane (PUR)	Clear
⑦	Countersunk Head Screw	Steel	Yellow Zinc Chromate

Item Code	Item Name	Load Capacity	Weight	Box	
100-019-183	PT-148	490 N	50 kgf	645 g	20 pcs

Zwei L is the flagship brand of Sugatsune and represents premium Japanese hardware quality.
Zwei L stands for "Zwei Lichter" in German: a dual highlight of mirror finish and lustrous satin on a faceted profile.

Manufactured from solid billets of the finest quality 316 stainless steel,

Zwei L brings the space luxury and dazzles your eyes.

Zwei L®



Video Link



Zwei L STAINLESS STEEL KNOB



ZL-1901



Features

- Made of highly corrosion resistant SUS316
- Ultrapremium Zwei L finish. Zwei L finish: Using top class polishing technology, these products combine the elegance of Satin with the deep glow of a Mirror.
- When combined with ZL-2302 (sold separately), can be used on glass.

Parts Included

M4x25 truss head screw (SUS)

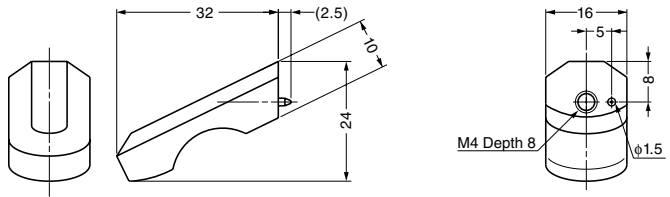

Item Code	Item Name	Material	Finish	Weight	Box
100-011-010	ZL-1901	Stainless Steel (SUS316)	Zwei L Finish	34 g	8 pcs

Zwei L STAINLESS STEEL KNOB



ZL-1902



Features

- Made of highly corrosion resistant SUS316
- Ultrapremium Zwei L finish. Zwei L finish: Using top class polishing technology, these products combine the elegance of Satin with the deep glow of a Mirror.
- When combined with ZL-2302 (sold separately), can be used on glass.

Parts Included

M4x25 truss head screw (SUS)

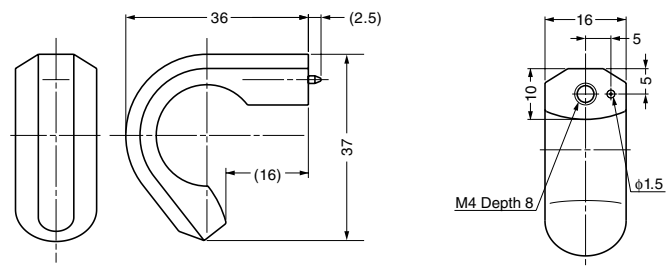

Item Code	Item Name	Material	Finish	Weight	Box
100-011-011	ZL-1902	Stainless Steel (SUS316)	Zwei L Finish	52 g	8 pcs

Zwei L STAINLESS STEEL KNOB



ZL-1903



Features

- Made of highly corrosion resistant SUS316
- Ultrapremium Zwei L finish. Zwei L finish: Using top class polishing technology, these products combine the elegance of Satin with the deep glow of a Mirror.
- When combined with ZL-2302 (sold separately), can be used on glass.

Parts Included

M4x25 truss head screw (SUS)

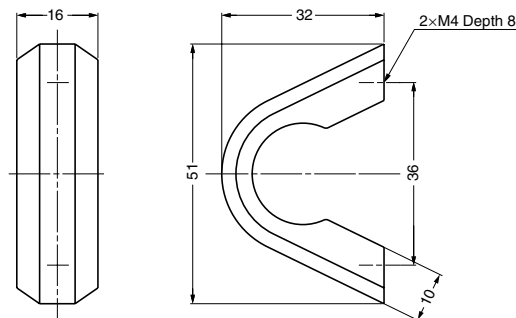

Item Code	Item Name	Material	Finish	Weight	Box
100-011-012	ZL-1903	Stainless Steel (SUS316)	Zwei L Finish	58 g	8 pcs

Zwei L STAINLESS STEEL KNOB



ZL-1904



Features

- Made of highly corrosion resistant SUS316
- Ultrapremium Zwei L finish. Zwei L finish: Using top class polishing technology, these products combine the elegance of Satin with the deep glow of a Mirror.
- When combined with ZL-2302 (sold separately), can be used on glass.

Parts Included

M4x25 truss head screw (SUS)

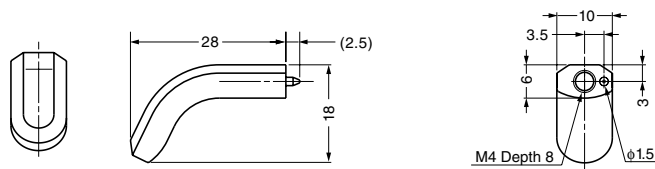

Item Code	Item Name	Material	Finish	Weight	Box
100-011-013	ZL-1904	Stainless Steel (SUS316)	Zwei L Finish	12 g	8 pcs

HANDLES,
PULLS & KNOBS

STAINLESS STEEL KNOB

Zwei L STAINLESS STEEL KNOB



ZL-1905

HANDLES,
PULLS & KNOBS

Features

- Made of highly corrosion resistant SUS316
- Ultrapremium Zwei L finish. Zwei L finish: Using top class polishing technology, these products combine the elegance of Satin with the deep glow of a Mirror.
- When combined with ZL-2302 (sold separately), can be used on glass.

Parts Included

Truss head screw M4x25 (SUS)

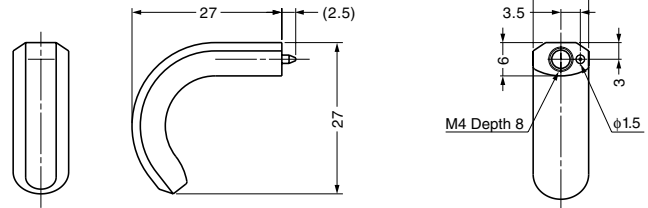

Item Code	Item Name	Material	Finish	Weight	Box
100-011-014	ZL-1905	Stainless Steel (SUS316)	Zwei L Finish	15 g	8 pcs

Zwei L KNOB BASE



ZL-2302



Knob is sold separately.

Plate + Screw Set for ZL-1904 and ZL-1905 Knobs (φ16)

Item Code	Item Name
100-010-976	ZL-2302-1916

No.	Part Name	Material	Finish/Colour	Box
①	Base Plate φ16	Stainless Steel (SUS316)	Zwei L Finish	1 pc
③	Gasket φ14	Elastomer (TPE)	Plain	2 pcs
⑤	Screw M4x16	Stainless Steel	Partially Zwei L Finish	1 pc

Features

- Zwei L series glass bracket for Zwei L knobs ZL-1901, ZL-1902, ZL-1903, ZL-1904, ZL-1905.
- Made of highly corrosion resistant SUS316
- Ultrapremium Zwei L finish. Zwei L finish: Using top class polishing technology, these products combine the elegance of Satin with the deep glow of a Mirror.
- Compatible glass thickness: 4-6mm

Plate + Screw Set for ZL-1901 and ZL-1903 Knobs (φ25)

Item Code	Item Name
100-010-977	ZL-2302-1925

No.	Part Name	Material	Finish/Colour	Box
②	Base Plate φ25	Stainless Steel(SUS316)	Zwei L Finish	1 pc
③	Gasket φ14	Elastomer(TPE)	Plain	1 pc
④	Gasket φ20	Elastomer(TPE)	Plain	1 pc
⑤	Screw M4x16	Stainless Steel	Partially Zwei L Finish	1 pc

*2 sets are necessary in use for ZL-1903.

Cut Out Dimensions

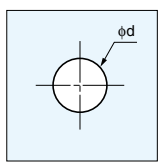
Glass thickness 4, 5 : d=5
Glass thickness 6 : d=6

① Base plate φ16

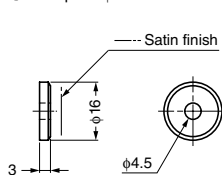

② Base plate φ25

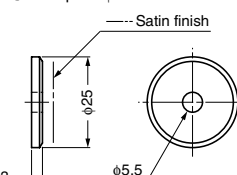

③ Gasket φ14

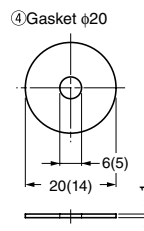

⑤ Screw M4x16

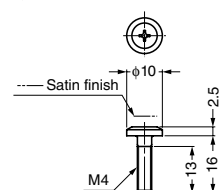

Zwei L STAINLESS STEEL KNOB



ZL-2503



Features

- Made of highly corrosion resistant SUS316
- Ultrapremium Zwei L finish. Zwei L finish: Using top class polishing technology, these products combine the elegance of Satin with the deep glow of a Mirror.
- Also available in the same design is ZL-1505 which can be attached to glass.

Parts Included

Screw M5x28 (SUS)

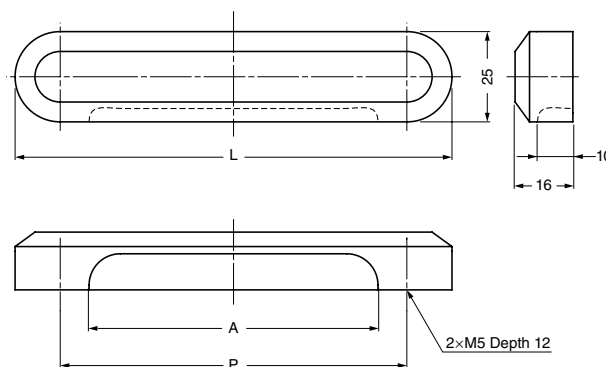

Item Code	Item Name	Material	Finish	L	P	A	Weight	Box
100-010-975	ZL-2503- 96	Stainless Steel (SUS316)	Zwei L Finish	121	96	84	334 g	4 pcs
100-010-974	ZL-2503-160	Stainless Steel (SUS316)	Zwei L Finish	185	160	148	496 g	2 pcs

Zwei L STAINLESS STEEL KNOB



ZL-1910



Features

- Made of highly corrosion resistant SUS316
- Ultrapremium Zwei L finish. Zwei L finish: Using top class polishing technology, these products combine the elegance of Satin with the deep glow of a Mirror.
- Built in screw-in type knob.
- Also available in the same design is ZL-1909 which can be attached to glass. ZL-2105 is a hook with the same design.

Parts Included

Truss head screw M4x28 (SUS)

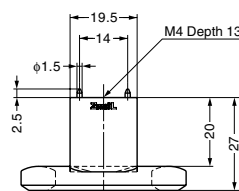

Cut Out Dimensions

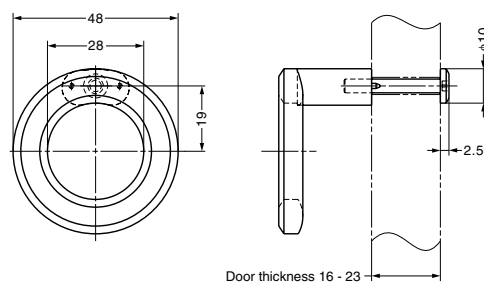
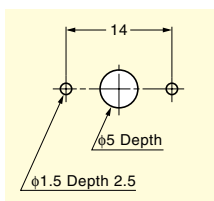

Item Code	Item Name	Material	Finish	Weight	Box
100-024-596	ZL-1910	Stainless Steel (SUS316)	Zwei L Finish	85 g	1 pc

HANDLES,
PULLS & KNOBS

STAINLESS STEEL KNOB

STAINLESS STEEL KNOB



RS-38S



Parts Included

Truss head screw M4x30 (SUS)

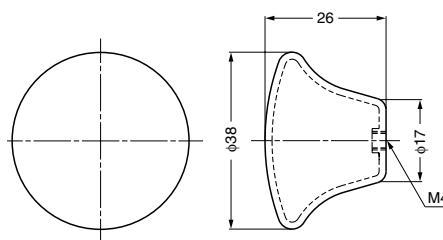

Item Code	Item Name	Material	Finish	Weight	Box	Carton
100-011-198	RS-38S	Stainless Steel (SUS304)	Satin	20 g	20 pcs	200 pcs

STAINLESS STEEL KNOB



RSS



Features

- Empty center makes knob very light.

Parts Included

Truss head screw (SUS)

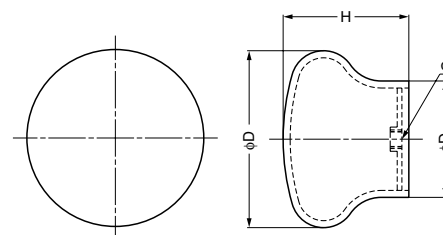

Item Code	Item Name	Material	Finish	H	D	D ₁	d	Screw	Weight	Box	Carton
100-011-194	RSS-25S	Stainless Steel (SUS304)	Satin	22	25	18	M4	M4x30	8.5 g	20 pcs	200 pcs
100-011-190	RSS-25M	Stainless Steel (SUS304)	Mirror	22	25	18	M4	M4x30	8.5 g	20 pcs	200 pcs
100-011-195	RSS-30S	Stainless Steel (SUS304)	Satin	23	30	20	M4	M4x30	11 g	20 pcs	200 pcs
100-011-191	RSS-30M	Stainless Steel (SUS304)	Mirror	23	30	20	M4	M4x30	11 g	20 pcs	200 pcs
100-011-196	RSS-38S	Stainless Steel (SUS304)	Satin	27	38	25	M5	M5x30	16 g	20 pcs	200 pcs
100-011-192	RSS-38M	Stainless Steel (SUS304)	Mirror	27	38	25	M5	M5x30	16 g	20 pcs	200 pcs
100-011-197	RSS-50S	Stainless Steel (SUS304)	Satin	34	50	35	M5	M5x30	30 g	20 pcs	200 pcs
100-011-193	RSS-50M	Stainless Steel (SUS304)	Mirror	34	50	35	M5	M5x30	30 g	20 pcs	200 pcs

STAINLESS STEEL KNOB



CU-L-35

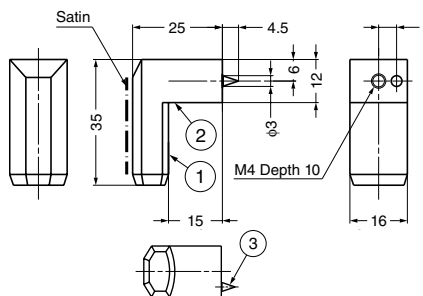

Features

- Exquisite combination of satin and mirror finishes

Parts Included

Truss head screw M4x25 (SUS)

Item Code	Item Name	Weight	Box
100-012-824	CU-L-35	60 g	10 pcs

No.	Part Name	Material	Finish
①	Body 1	Stainless Steel (SUS303)	Mirror and Satin Combination
②	Body 2	Stainless Steel (SUS304)	Mirror
③	Pin	Stainless Steel (SUS303)	Mirror

STAINLESS STEEL PULL



SD

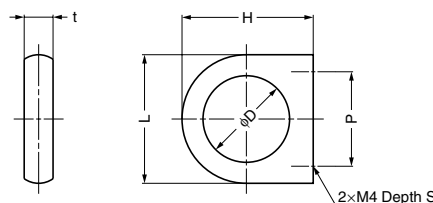

Parts Included

Truss head screw M4x25 (SUS)

Item Code	Item Name	Material	Finish	L	H	t	D	P	S	Weight	Box	Carton
100-015-022	SD-24S	Stainless Steel (SCS13)	Satin	24.5	25	5.5	16.5	18	5	10 g	80 pcs	800 pcs
100-015-023	SD-24M	Stainless Steel (SCS13)	Mirror	24.5	25	5.5	16.5	18	5	10 g	80 pcs	800 pcs
100-015-020	SD-30S	Stainless Steel (SCS13)	Satin	30.5	31.5	6.5	20.5	21	6	22 g	50 pcs	500 pcs
100-015-021	SD-30M	Stainless Steel (SCS13)	Mirror	30.5	31.5	6.5	20.5	21	6	22 g	50 pcs	500 pcs

STAINLESS STEEL PULL



HS

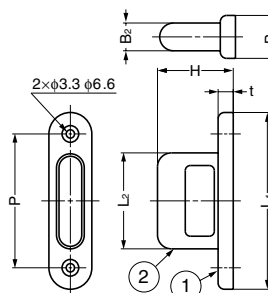

Features

- Made from elastomer for a soft, pleasant touch.
- Bottom is made from stainless steel.

Parts Included

Countersunk head wood screw 3.1x20 (SUS)

No.	Material	Finish/Colour
①	Stainless Steel (SUS304)	Satin
②	Elastomer (TPE)	Black

Item Code	Item Name	L ₁	L ₂	P	B ₁	B ₂	H	t	Weight	Box	Carton
100-012-192	HS-60S	60	30	44	16	9	25	5	13 g	40 pcs	400 pcs
100-012-193	HS-70S	70	38	53	17	11	30	6	20 g	30 pcs	300 pcs

STAINLESS STEEL PULL



RD

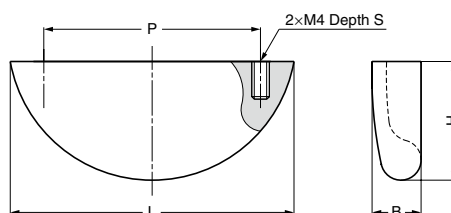

Features

- Gentle curving design makes it fit the shape of hands and makes it easy to grab.

Parts Included

Truss head screw M4x25 (SUS)

Item Code	Item Name	Material	Finish	L	H	B	P	S	Weight	Box	Carton
100-901-049	RD-55SM	Stainless Steel (SCS14)	Mirror	55	23	9.5	42	8	50 g	30 pcs	360 pcs
100-901-050	RD-90SM	Stainless Steel (SCS14)	Mirror	90	25.5	10.5	74	10	80 g	20 pcs	240 pcs

*SCS14 is equivalent of SUS316.

KNOB



KK-T



Features

With antibacterial coating.

Parts Included

Truss head screw M4x30

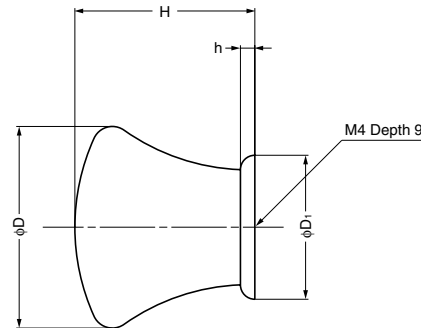

Item Code	Item Name	Material	Finish	D	D ₁	H	h	Weight	Box	Carton
100-012-905	KK-T24SNI	Aluminium Alloy	Nickel+Antibacterial Coating	24	16	23	1.5	10 g	25 pcs	200 pcs
100-012-906	KK-T24SSG	Aluminium Alloy	Satin Gold+Antibacterial Coating	24	16	23	1.5	10 g	25 pcs	200 pcs
100-012-907	KK-T24SBR	Aluminium Alloy	Brown+Antibacterial Coating	24	16	23	1.5	10 g	25 pcs	200 pcs
100-029-090	*KK-T24BL	Aluminium Alloy	Paint/Black	24	16	23	1.5	10 g	25 pcs	200 pcs
100-012-908	KK-T28SNI	Aluminium Alloy	Nickel+Antibacterial Coating	28	20	26	2	20 g	25 pcs	200 pcs
100-012-909	KK-T28SSG	Aluminium Alloy	Satin Gold+Antibacterial Coating	28	20	26	2	20 g	25 pcs	200 pcs
100-012-910	KK-T28SBR	Aluminium Alloy	Brown+Antibacterial Coating	28	20	26	2	20 g	25 pcs	200 pcs
100-029-091	*KK-T28BL	Aluminium Alloy	Paint/Black	28	20	26	2	20 g	25 pcs	200 pcs

*Without antibacterial coating.

KNOB



KK-B



Features

With antibacterial coating.

Parts Included

Truss head screw M4x30

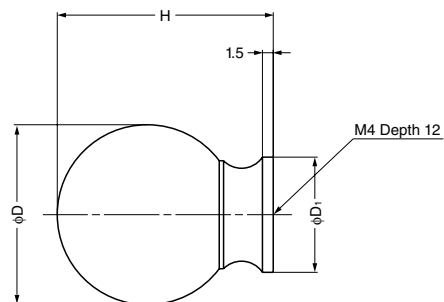

Item Code	Item Name	Material	Finish	D	D ₁	H	Weight	Box	Carton
100-012-881	KK-B20SNI	Aluminium Alloy	Nickel+Antibacterial Coating	20	13	26	10 g	25 pcs	200 pcs
100-012-882	KK-B20SSG	Aluminium Alloy	Satin Gold+Antibacterial Coating	20	13	26	10 g	25 pcs	200 pcs
100-012-883	KK-B20SBR	Aluminium Alloy	Brown+Antibacterial Coating	20	13	26	10 g	25 pcs	200 pcs
100-012-884	KK-B25SNI	Aluminium Alloy	Nickel+Antibacterial Coating	25	16	30	25 g	25 pcs	200 pcs
100-012-885	KK-B25SSG	Aluminium Alloy	Satin Gold+Antibacterial Coating	25	16	30	25 g	25 pcs	200 pcs
100-012-886	KK-B25SBR	Aluminium Alloy	Brown+Antibacterial Coating	25	16	30	25 g	25 pcs	200 pcs

PULL

AOT35



Features

- Smooth curves produce a visually desirable handle.
- Inward curving dimples on the top and bottom make it easy to grab.

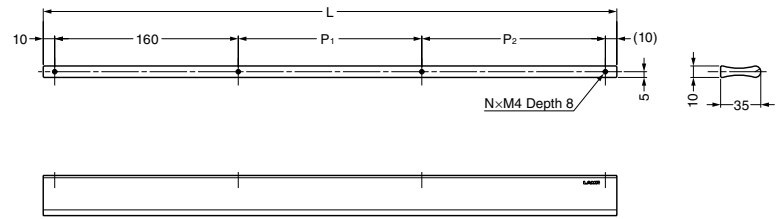

Item Code	Item Name	Material	Finish	L	P ₁	P ₂	N	Weight	Box
100-012-523	AOT35-180	Aluminium Alloy	Anodized	180	-	-	2	129 g	100
100-012-524	AOT35-340	Aluminium Alloy	Anodized	340	160	-	3	243 g	50
100-012-525	AOT35-500	Aluminium Alloy	Anodized	500	160	160	4	358 g	30

HANDLES,
PULLS & KNOBS

PULL

GF-100

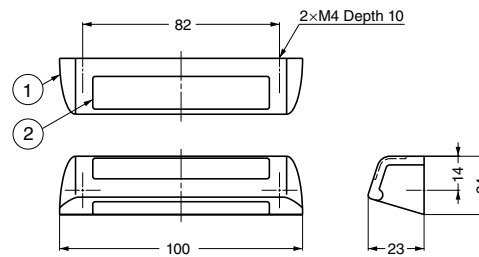

Item Code	Item Name	Weight	Box	Carton
100-010-273	GF-100	21 g	80 pcs	480 pcs

No.	Material	Finish/Colour
①	ABS	Black
②	Aluminium Sheet	Satin

PULL / KNOB

KNOB



EXSEL

Parts Included

Truss head screw M4x25

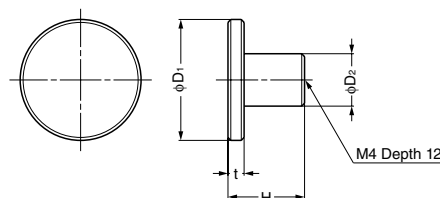

Item Code	Item Name	Material	Finish	D ₁	D ₂	H	t	Weight	Box	Carton
100-012-080	EXSEL20	Aluminium Alloy	Stainless Anodized	20	10	18	4	5 g	48 pcs	1152 pcs
100-012-081	EXSEL25	Aluminium Alloy	Stainless Anodized	25	11	18.5	4.5	8.5 g	48 pcs	1152 pcs
100-012-082	EXSEL30	Aluminium Alloy	Stainless Anodized	30	12	19	5	15 g	48 pcs	1152 pcs
100-012-083	EXSEL35	Aluminium Alloy	Stainless Anodized	35	13	19	5	16.5 g	24 pcs	576 pcs

TAMAZUSA KNOB



TMT

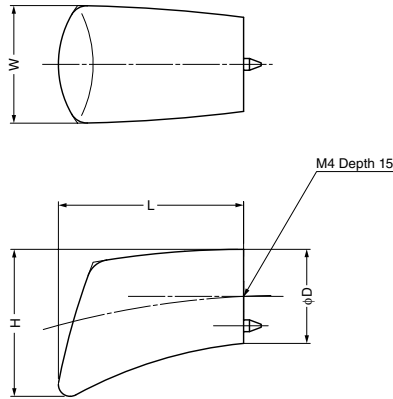

Features

- This interior concept is inspired by the splendor and traditional beauty of 16th century Japanese culture. By transplanting these designs into the modern world, the "Tamazusa" series was born. The series emulates "Ryusui" flowing water Japanese design and has gentle soft lines, providing a comforting and desirable aesthetic.
- The Tamazusa series has knobs, door handles and lever handles.
- This knob is covered in 24k gold plating.

Parts Included

Truss head screw M4x30 (SUS)

Item Code	Item Name	Material	Finish	W	L	H	D	Weight	Box	Carton
100-010-730	TMT-16	Brass	24K Gold Plating	16	25	20	12.5	31 g	1 pc	10 pcs
100-010-731	TMT-20	Brass	24K Gold Plating	20	31.5	25	16	64 g	1 pc	10 pcs

KNOB



GLA

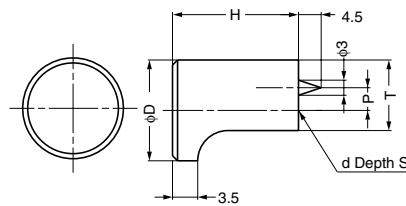

Parts Included

- GLA-12:
Truss head screw M3x25
- GLA-16, GLA-20:
Truss head screw M4x25

Item Code	Item Name	Material	Finish	D	H	T	P	d	S	Weight	Box	Carton
100-010-718	GLA-12	Brass	Satin Nickel	12	18	8.5	3.5	M3	8	14 g	50 pcs	500 pcs
100-012-323	GLA-16	Brass	Satin Nickel	16	22	11	4	M4	10	29 g	40 pcs	400 pcs
100-010-720	GLA-20	Brass	Satin Nickel	20	25	14	4.5	M4	10	52 g	40 pcs	400 pcs

KNOB



MRB

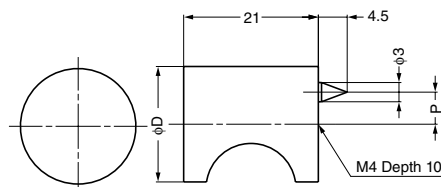

Parts Included

Truss head screw M4x25

Item Code	Item Name	Material	Finish	D	P	Weight	Box	Carton
100-010-721	MRB-18	Brass	Satin Nickel	18	5	38 g	30 pcs	300 pcs
100-010-722	MRB-24	Brass	Satin Nickel	24	5.5	70 g	30 pcs	300 pcs

KNOB

Discontinued

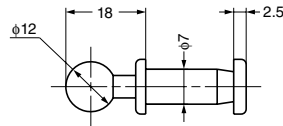

MBT-12

Parts Included

Countersunk head screw M4x5

Cut Out Dimensions

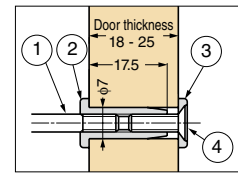

No.	Part Name	Material	Finish
①	Knob	Brass	Satin Nickel
②	Sleeve	Brass	Satin Nickel
③	Washer	Brass	Nickel
④	Screw	Steel	Nickel

Item Code	Item Name	Weight	Box	Carton
100-012-277	MBT-12WB	20 g	30 pcs	300 pcs

KNOB

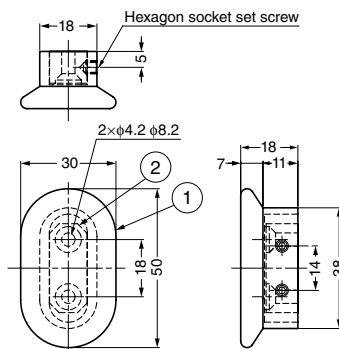

DW-50N

Features

Includes insert block and set screw for surface mounting.

Parts Included

Countersunk head screw M4x20 (SUS)

No.	Part Name	Finish
①	Body	Satin Chrome
②	Base	Plain

Item Code	Item Name	Material	Weight	Box
100-010-005	DW-50N	Brass	130 g	20 pcs

KNOB

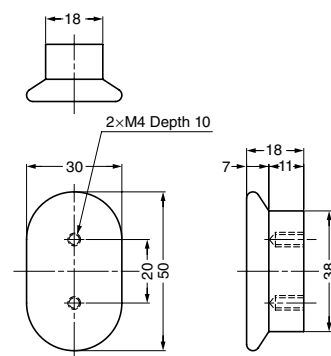

DW-50

Item Code	Item Name	Material	Finish	Weight	Box
100-017-633	DW-50	Brass	Satin Chrome	130 g	20 pcs

BRASS KNOB



KHE103

Parts Included

Truss head screw M4x30

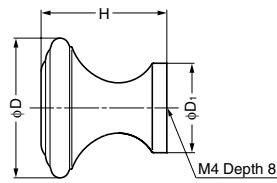

Item Code	Item Name	Material	Finish	D	D ₁	H	Weight	Box
100-012-618	KHE103-25PB	Brass	Mirror, Clear	25	16	22.5	34 g	20 pcs
100-015-018	KHE103-32PB	Brass	Mirror, Clear	31	19	22.5	55 g	20 pcs

BRASS KNOB



SY

Parts Included

Truss head screw M4x25

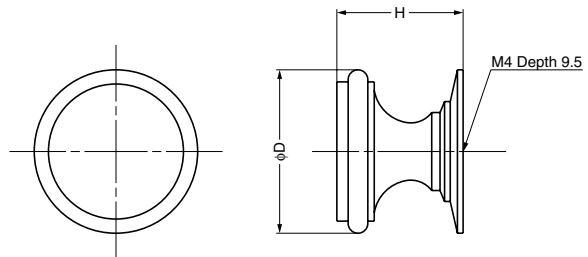

Item Code	Item Name	Material	Finish	D	H	Weight	Box	Carton
100-012-032	SY-16WB	Brass	Satin Nickel	16	15	10 g	40 pcs	400 pcs
100-012-030	SY-16M	Brass	Mirror	16	15	10 g	40 pcs	400 pcs
100-010-238	SY-22WB	Brass	Satin Nickel	22	17	21 g	30 pcs	300 pcs
100-017-634	SY-22M	Brass	Mirror	22	17	21 g	30 pcs	300 pcs

KNOB



TS

Parts Included

Truss head screw M4x25

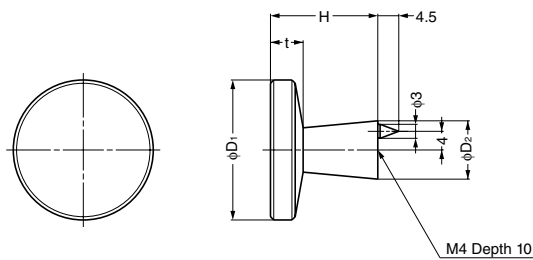

Item Code	Item Name	Material	Finish	D ₁	D ₂	H	t	Weight	Box	Carton
100-010-001	TS-25	Brass	Satin Nickel	25	14.5	23	6.7	36 g	50 pcs	200 pcs
100-013-119	TS-30	Brass	Satin Nickel	30	14.5	23	6.7	47 g	50 pcs	200 pcs
100-010-002	TS-36	Brass	Satin Nickel	36	15	24	7.5	70 g	30 pcs	120 pcs

BRASS KNOB



B046

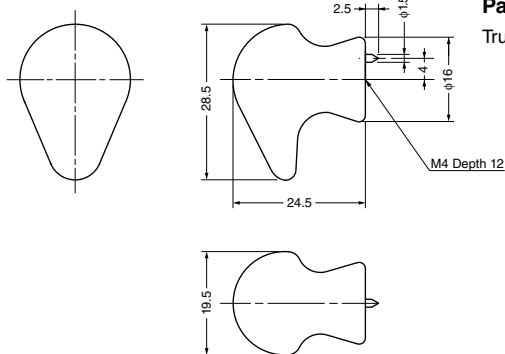

Parts Included
Truss head screw M4x28

Item Code	Item Name	Material	Finish	Weight	Box	Carton
100-012-760	B046-30PB	Brass	Brass	45 g	20 pcs	200 pcs
100-012-761	B046-30CR	Brass	Chrome	45 g	20 pcs	200 pcs
100-012-762	B046-30BN	Brass	Black Nickel	45 g	20 pcs	200 pcs
100-012-763	B046-30SN	Brass	Nickel	45 g	20 pcs	200 pcs
100-012-764	B046-30SG	Brass	Satin Gold	45 g	20 pcs	200 pcs

BRASS KNOB



B671

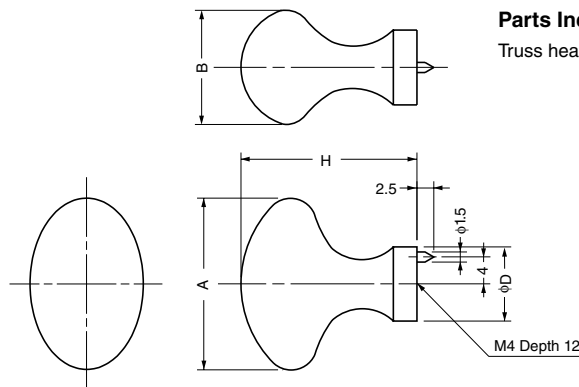

Parts Included
Truss head screw M4x28

Item Code	Item Name	Material	Finish	A	B	H	D	Weight	Box	Carton
100-012-767	B671-25PB	Brass	Brass	25.5	16.8	26.1	11	30 g	40 pcs	400 pcs
100-012-768	B671-25CR	Brass	Chrome	25.5	16.8	26.1	11	30 g	40 pcs	400 pcs
100-012-770	B671-30PB	Brass	Brass	30.8	19.9	32.5	14	62 g	20 pcs	200 pcs
100-012-771	B671-30CR	Brass	Chrome	30.8	19.9	32.5	14	62 g	20 pcs	200 pcs

BRASS KNOB



KHE102

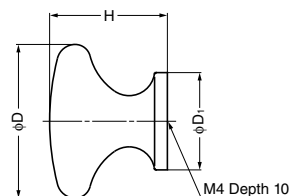

Parts Included
Truss head screw M4x30

Item Code	Item Name	Material	Finish	D	D ₁	H	Weight	Box
100-012-621	KHE102-30PB	Brass	Mirror, Clear	30	19	23	63 g	20 pcs
100-012-741	KHE102-35PB	Brass	Mirror, Clear	35	22	25	84 g	20 pcs

HANDLES,
PULLS & KNOBS

KNOB

BRASS KNOB



KHE107

Parts Included

Truss head screw M4x30

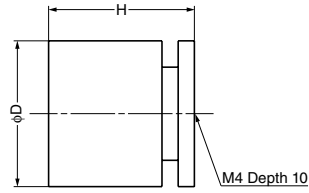

Item Code	Item Name	Material	Finish	D	H	Weight	Box
100-012-619	KHE107-18PB	Brass	Mirror, Clear	18	18	34 g	20 pcs
100-016-318	KHE107-25PB	Brass	Mirror, Clear	25	25	96 g	20 pcs

BRASS KNOB



KHE111

Parts Included

Truss head screw M4x30

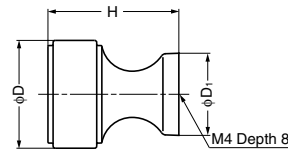

Item Code	Item Name	Material	Finish	D	D ₁	H	Weight	Box
100-016-319	KHE111-16PB	Brass	Mirror, Clear	16	12	18.5	17 g	20 pcs
100-012-740	KHE111-22PB	Brass	Mirror, Clear	21	16	25.5	43 g	20 pcs

BRASS KNOB



KE101-30

Parts Included

Truss head screw M4x30

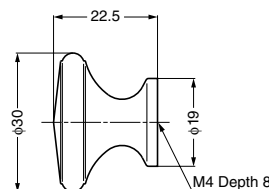

Item Code	Item Name	Material	Finish	Weight	Box
100-015-019	KHE101-30PB	Brass	Mirror, Clear	54 g	20 pcs

PULL



RD

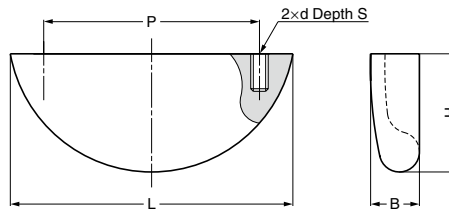

Features

Gentle curving design makes it fit the shape of hands and makes it easy to grab.

Parts Included

Truss head screw
*Screws not included with RD-45CR-SA.

HANDLES,
PULLS & KNOBS

PULL / KNOB

Item Code	Item Name	Material	Finish	L	P	H	B	d	S	Screw	Weight	Box	Carton
100-012-331	RD-45CR	Zinc Alloy (ZDC)	Chrome	45	32	19	8.2	M3	7	M3x28	22 g	40 pcs	480 pcs
100-012-333	RD-45WB	Zinc Alloy (ZDC)	Satin Nickel	45	32	19	8.2	M3	7	M3x28	22 g	40 pcs	480 pcs
100-012-330	RD-45BN	Zinc Alloy (ZDC)	Black Nickel	45	32	19	8.2	M3	7	M3x28	22 g	40 pcs	480 pcs
100-012-332	RD-45SG	Zinc Alloy (ZDC)	Gold	45	32	19	8.2	M3	7	M3x28	22 g	40 pcs	480 pcs
100-012-387	RD-45SL	Zinc Alloy (ZDC)	Paint/Silver	45	32	19	8.2	M3	7	M3x28	22 g	40 pcs	480 pcs
100-019-401	RD-45CR-SA	Zinc Alloy (ZDC)	Chrome	45	32	19	8.2	M3	7	Not Included	22 g	100 pcs	400 pcs
100-012-335	RD-55CR	Zinc Alloy (ZDC)	Chrome	55	42	23	9.5	M4	8	M4x28	35 g	30 pcs	360 pcs
100-012-337	RD-55WB	Zinc Alloy (ZDC)	Satin Nickel	55	42	23	9.5	M4	8	M4x28	35 g	30 pcs	360 pcs
100-012-334	RD-55BN	Zinc Alloy (ZDC)	Black Nickel	55	42	23	9.5	M4	8	M4x28	35 g	30 pcs	360 pcs
100-012-336	RD-55SG	Zinc Alloy (ZDC)	Gold	55	42	23	9.5	M4	8	M4x28	35 g	30 pcs	360 pcs
100-012-162	RD-90CR	Zinc Alloy (ZDC)	Chrome	90	74	25.5	10.5	M4	9.5	M4x28	63 g	20 pcs	240 pcs
100-012-341	RD-90WB	Zinc Alloy (ZDC)	Satin Nickel	90	74	25.5	10.5	M4	9.5	M4x28	63 g	20 pcs	240 pcs
100-012-338	RD-90BN	Zinc Alloy (ZDC)	Black Nickel	90	74	25.5	10.5	M4	9.5	M4x28	63 g	20 pcs	240 pcs
100-012-340	RD-90SG	Zinc Alloy (ZDC)	Gold	90	74	25.5	10.5	M4	9.5	M4x28	63 g	20 pcs	240 pcs

DIE CAST MODERN KNOB



MKZ



Parts Included

Truss head screw M4x25

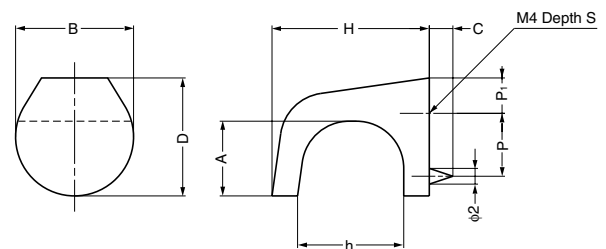

Item Code	Item Name	Material	Finish	D	A	B	C	H	h	P	P ₁	S	Weight	Box	Carton
100-018-042	MKZ-15PB	Zinc Alloy (ZDC)	Brass/Clear	16	8	15	2	20	13.5	8	5.5	6	11 g	50 pcs	500 pcs
100-018-043	MKZ-15CR	Zinc Alloy (ZDC)	Chrome	16	8	15	2	20	13.5	8	5.5	6	11 g	50 pcs	500 pcs
100-018-044	MKZ-15BNI	Zinc Alloy (ZDC)	Black Nickel	16	8	15	2	20	13.5	8	5.5	6	11 g	50 pcs	500 pcs
100-018-045	MKZ-15WB	Zinc Alloy (ZDC)	Satin Nickel	16	8	15	2	20	13.5	8	5.5	6	11 g	50 pcs	500 pcs
100-018-046	MKZ-15SB	Zinc Alloy (ZDC)	Satin Gold	16	8	15	2	20	13.5	8	5.5	6	11 g	50 pcs	500 pcs
100-018-047	MKZ-21PB	Zinc Alloy (ZDC)	Brass/Clear	21	12.5	20	3	26	17	12	4.5	7	29 g	50 pcs	500 pcs
100-018-048	MKZ-21CR	Zinc Alloy (ZDC)	Chrome	21	12.5	20	3	26	17	12	4.5	7	29 g	50 pcs	500 pcs
100-018-049	MKZ-21BNI	Zinc Alloy (ZDC)	Black Nickel	21	12.5	20	3	26	17	12	4.5	7	29 g	50 pcs	500 pcs
100-018-050	MKZ-21WB	Zinc Alloy (ZDC)	Satin Nickel	21	12.5	20	3	26	17	12	4.5	7	29 g	50 pcs	500 pcs
100-018-051	MKZ-21SB	Zinc Alloy (ZDC)	Satin Gold	21	12.5	20	3	26	17	12	4.5	7	29 g	50 pcs	500 pcs

KNOB



KM-130

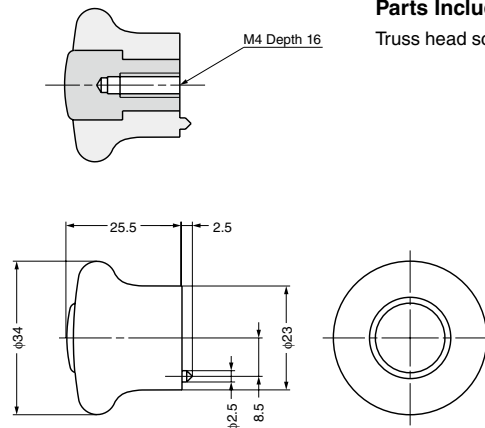

Parts Included

Truss head screw M4x30

Item Code	Item Name	Material	Finish	Weight	Box	Carton
100-051-509	KM130SN/SN	Zinc Alloy (ZDC)	Satin Nickel/Clear	117 g	30 pcs	120 pcs
100-051-508	KM130SG/SG	Zinc Alloy (ZDC)	Satin Gold/Clear	117 g	30 pcs	120 pcs

FIRE RESISTANT RESIN KNOB



SGL

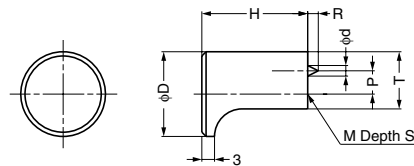

Features

- Uses flame retardant resin material that has a UL94-HB rating.

Parts Included

- SGL-12 : Truss head screw M3x28
- SGL-16 : Truss head screw M4x28

Item Code	Item Name	Material	Finish	D	H	T	P	d	R	M	S	Weight	Box	Carton
100-012-016	SGL-12	ABS	Satin Chrome	12	18	8.5	3	2	2	M3	9.5	1 g	60 pcs	1,800 pcs
100-012-017	SGL-16	ABS	Satin Chrome	16	22	11	4	2	2.5	M4	13.5	2 g	40 pcs	1,200 pcs
100-012-018	SGL-20	ABS	Satin Chrome	20	25	13.5	5	2.5	2.5	M4	15.5	3.5 g	30 pcs	900 pcs

KNOB



GD-20

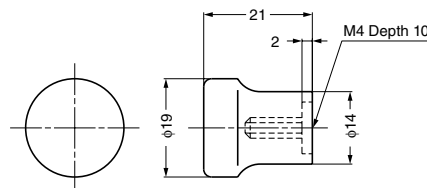

Parts Included

Truss head screw M4x25

Item Code	Item Name	Material	Colour	Weight	Box	Carton
100-012-074	GD-20	ABS	Black	5 g	50 pcs	500 pcs

KNOB

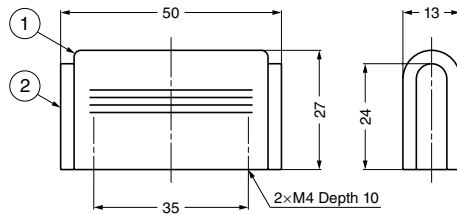

FS-04-S

Parts Included
Truss head screw M4x25

No.	Material	Colour
①	Elastomer (TPE)	Black
②	Aluminium Alloy	Anodized Silver+Satin

Item Code	Item Name	Weight	Box	Carton
100-012-173	FS-04-S	28 g	30 pcs	360 pcs

KNOB

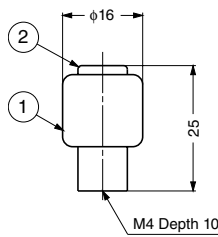

FS-06-S

Parts Included
Truss head screw M4x25

No.	Material	Colour
①	Elastomer (TPE)	Black
②	Aluminium Alloy	Anodized Silver+Satin

Item Code	Item Name	Weight	Box	Carton
100-012-175	FS-06-S	6 g	30 pcs	300 pcs

KNOB



UIB-20

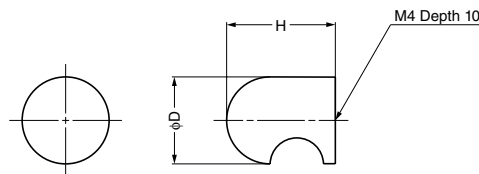

UIB

Parts Included
Truss head screw M4x28

Item Code	Item Name	Material	D	H	Weight	Box	Carton
100-012-410	UIB-16	Polyester	16	24	5.5 g	30 pcs	300 pcs
100-012-411	UIB-20	Polyester	20	30	10 g	25 pcs	250 pcs

KNOB



UIA-26

UIA-20

UIA-30

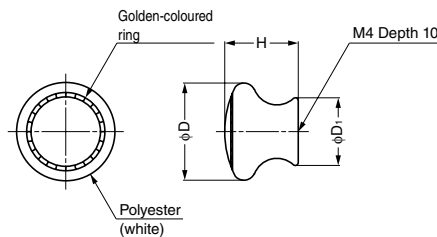

UIA

Parts Included
Truss head screw M4x28

Item Code	Item Name	Material	D	D ₁	H	Weight	Box	Carton
100-012-400	UIA-20	Polyester	25	18	22	6.5 g	25 pcs	250 pcs
100-012-401	UIA-26	Polyester	33	23	25	14.5 g	15 pcs	150 pcs
100-012-402	UIA-30	Polyester	38	25	28	20 g	10 pcs	100 pcs

KNOB



UID-20

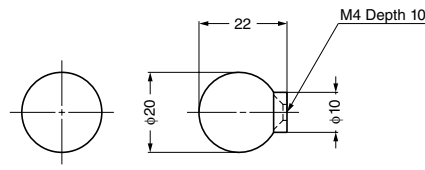

Parts Included
Truss head screw M4x28

Item Code	Item Name	Material		Finish/Colour		Weight	Box	Carton
		Body	Base	Body	Base			
100-012-430	UID-20W	Polyester	Brass	White	Chrome	7 g	30 pcs	300 pcs
100-012-432	UID-20BE	Polyester	Brass	Umber	Gold	7 g	30 pcs	300 pcs
100-012-431	UID-20G	Polyester	Brass	Grey	Black Chrome	7 g	30 pcs	300 pcs
100-012-433	UID-20BR	Polyester	Brass	Brown	Nickel	7 g	30 pcs	300 pcs

KNOB



215F

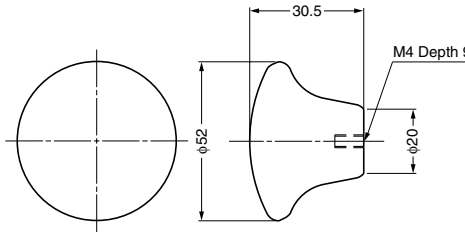

Parts Included
Truss head screw M4x25

Item Code	Item Name	Material	Colour	Weight	Box	Carton
100-017-649	215F	Ceramic	White	55 g	20 pcs	80 pcs

KNOB



231F, 232F, 217F

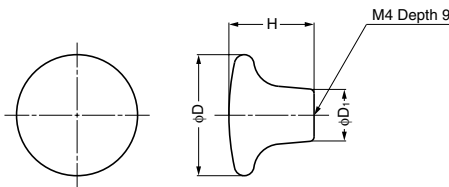

Parts Included
Truss head screw M4x25

Item Code	Item Name	Material	Colour	D	D ₁	H	Weight	Box	Carton
100-012-098	231F	Ceramic	White	26	16	19	12 g	50 pcs	200 pcs
100-012-099	232F	Ceramic	White	32	15.5	23	17 g	50 pcs	200 pcs
100-012-095	217F	Ceramic	White	39	17.5	26	26 g	50 pcs	200 pcs

KNOB



229F

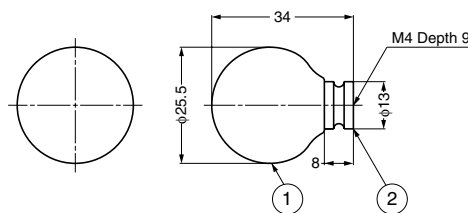

Parts Included
Truss head screw M4x35

No.	Material	Finish/Colour
①	Ceramic	White
②	Brass	Plain

Item Code	Item Name	Weight	Box	Carton
100-012-097	229F	23 g	50 pcs	200 pcs

WOOD KNOB



SMT



Features

- Natural wood rounded oval knob. Can be painted to fully integrate into interiors.
- Available in custom finishes, please contact us for details.

Parts Included

Truss head screw M4x25

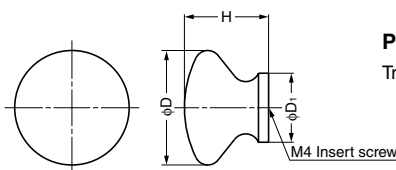

Item Code	Item Name	Material	Finish	D	D ₁	H	Weight	Box
100-012-001	SMT24	Wood	Plain	24.5	15	19	5 g	200 pcs
100-012-010	SMT34	Wood	Plain	34	20.5	25	10 g	80 pcs
100-012-011	SMT38	Wood	Plain	39.5	22	29.5	15 g	50 pcs
100-012-004	SMT45	Wood	Plain	45	26	33	18 g	25 pcs

WOOD KNOB



SMRB



Features

- Natural wood cylindrical knob. Can be painted to fully integrate into interiors.
- Available in custom finishes, please contact us for details.

Parts Included

Truss head screw M4x25

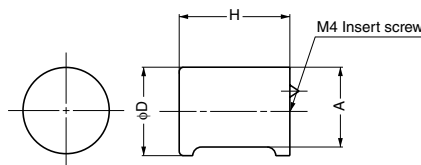

Item Code	Item Name	Material	Finish	D	H	A	Weight	Box
100-012-006	SMRB16	Wood	Plain	16	22	13.5	5 g	250 pcs
100-012-007	SMRB20	Wood	Plain	20	25	16.5	7 g	150 pcs
100-012-008	SMRB24	Wood	Plain	24	29	19.5	9 g	100 pcs

WOOD RECESSED PULL

SU-T



Cut Out Dimensions

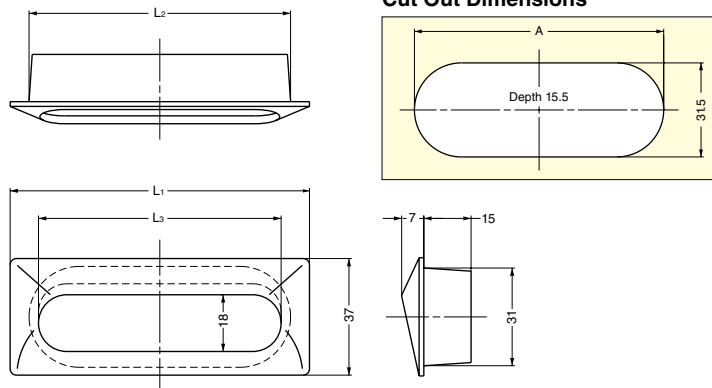

Item Code	Item Name	Material	Finish	L ₁	L ₂	L ₃	A	Weight	Box	Carton
100-012-878	SU- T75	Wood	Plain	75	63	58	63.5	14 g	25 pcs	250 pcs
100-012-879	SU- T95	Wood	Plain	95	83	77	83.5	17 g	20 pcs	200 pcs
100-012-880	SU-T115	Wood	Plain	115	103	95	103.5	24 g	15 pcs	150 pcs

*Limited stock available. Please contact your vendor.



Zwei L

Zwei L is the flagship brand of Sugatsune and represents premium Japanese hardware quality.

Zwei L stands for "Zwei Lichter" in German: a dual highlight of mirror finish and lustrous satin on a faceted profile.

Manufactured from solid billets of the finest quality 316 stainless steel, **Zwei L** brings the space luxury and dazzles your eyes.

Video Link



Zwei L®

Zwei L STAINLESS STEEL PUSH KNOB



ZL-1908



Features

- By pressing in the knob, can become flat and flush with its surroundings, giving doors a seamless appearance. This also makes it safer by removing the chance of clothes getting caught or people walking into a protrusion from the door.
- Ultrapremium Zwei L finish. Zwei L finish: Using top class polishing technology, these products combine the elegance of Satin with the deep glow of a Mirror.

Parts Included

Truss head screw M3×25 (SUS)

Cut Out Dimensions

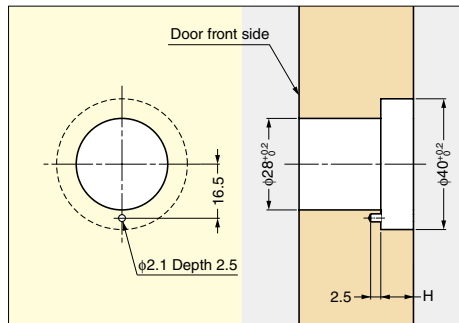

Door Thickness 13-23 mm

Door Thickness 24-33 mm

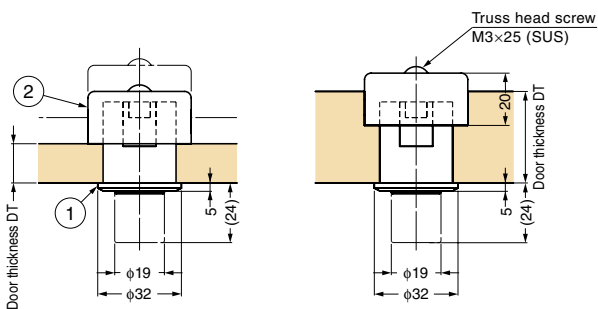

No.	Part Name	Material	Finish/Colour
①	Knob Body	Stainless Steel (SUS316)	Zwei L Finish
②	Knob Cap	ABS	Black

Item Code	Item Name	Door Thickness (DT)	Bore Depth H	Weight	Box
100-011-033	ZL-1908	13 - 33	DT 13 - 23: H=None (φ28 Hole), DT 24 - 33: H=DT-23	134 g	1 pc

PUSH KNOB

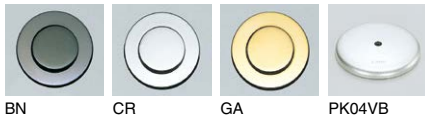

Part Name	Material
Push Knob	Zinc Alloy (ZDC)
Latch Body	ABS
Cap	ABS

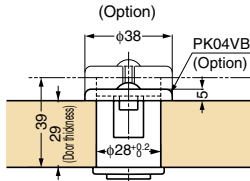

Features

- Push in knob to make it flush
- 15-35mm thickness without cap, 29-39mm with cap (PK04VB, sold separately)

Remarks

Install with bracket when applied to sheet metal.

Parts Included

Truss head screw M3x20 (SUS)

Option

Cap for thick door (PK04VB)

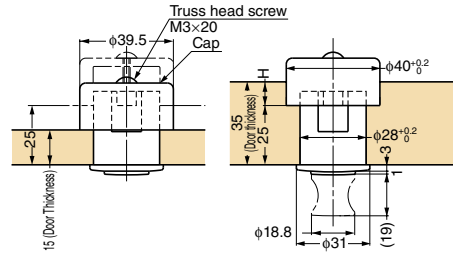

PK03

Cut Out Dimensions

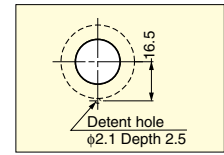

Bracket for Sheet Metal

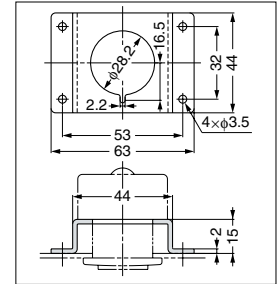

Body

Item Code	Item Name	Finish	Door Thickness (DT)	Bore Depth H	Weight	Box	Carton
100-019-954	PK03GA	Gold	15 - 35	DT 15 - 25: H=None (φ28 Hole), DT 26 - 35: H=DT-25	67 g	20 pcs	200 pcs
100-019-956	PK03CR	Chrome	15 - 35	DT 15 - 25: H=None (φ28 Hole), DT 26 - 35: H=DT-25	67 g	20 pcs	200 pcs
100-019-955	PK03BN	Black Nickel	15 - 35	DT 15 - 25: H=None (φ28 Hole), DT 26 - 35: H=DT-25	67 g	20 pcs	200 pcs

Cap for Thick Doors (Option)

Item Code	Item Name	Door Thickness	Material	Finish	Weight	Box	Carton
100-910-039	PK04VB	29 - 39	Stainless Steel (SUS430)	Plain	13 g	100 pcs	800 pcs

PUSH KNOB



Part Name	Material
Push Knob	Zinc Alloy (ZDC)
Latch Body	ABS
Cap	ABS

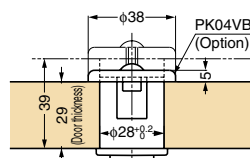

Features

- Push in knob to make it flush
- 15-35mm thickness without cap, 29-39mm with cap (PK04VB, sold separately)

Remarks

Install with bracket when applied to sheet metal.

Parts Included

Truss head screw M3x20

Option

Cap for thick door (PK04VB)

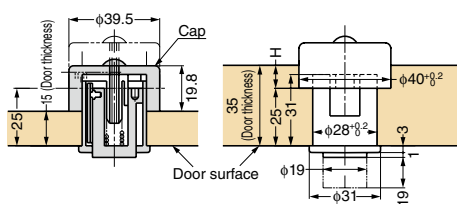

PK04

Cut Out Dimensions

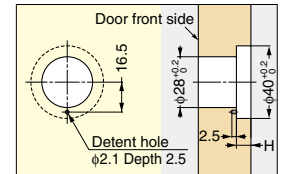

Bracket for Sheet Metal

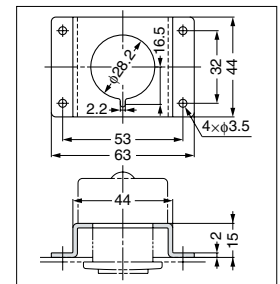

Body

Item Code	Item Name	Finish	Door Thickness (DT)	Bore Depth H	Weight	Box	Carton
100-015-025	PK04GA	Gold	15 - 35	DT 15 - 25: H=None (φ28 Hole), DT 26 - 35: H=DT-25	76 g	20 pcs	200 pcs
100-015-024	PK04CR	Chrome	15 - 35	DT 15 - 25: H=None (φ28 Hole), DT 26 - 35: H=DT-25	76 g	20 pcs	200 pcs
100-015-026	PK04BN	Black Nickel	15 - 35	DT 15 - 25: H=None (φ28 Hole), DT 26 - 35: H=DT-25	76 g	20 pcs	200 pcs
100-012-554	PK04DN	Nickel	15 - 35	DT 15 - 25: H=None (φ28 Hole), DT 26 - 35: H=DT-25	76 g	20 pcs	200 pcs

Cap for Thick Doors (Option)

Item Code	Item Name	Door Thickness	Material	Finish	Weight	Box	Carton
100-910-039	PK04VB	29 - 39	Stainless Steel (SUS430)	Plain	13 g	100 pcs	800 pcs



Zwei L is the flagship brand of Sugatsune and represents premium Japanese hardware quality.
Zwei L stands for "Zwei Lichter" in German: a dual highlight of mirror finish and lustrous satin on a faceted profile.
 Manufactured from solid billets of the finest quality 316 stainless steel,
Zwei L brings the space luxury and dazzles your eyes.

Video Link



Zwei L STAINLESS STEEL DOOR HANDLE

STAINLESS
316
STEEL

ZL-1501

Features

- Made of highly corrosion resistant SUS316
- Ultrapremium Zwei L finish. Zwei L finish: Using top class polishing technology, these products combine the elegance of Satin with the deep glow of a Mirror.
- Can be installed on both sides of glass, metal or wooden doors. Can also be installed on a single side of glass, wood or metal doors. Please refer to the door handle sets below.
- Dual side handle sets use ZL-1501-WN with ZL-1501-WR and are attached by ZL-1501-IS (for the outside) and ZL-1501-IS (for the inside)

Remarks

- Screws are not included in ZL-1501-IS and ZL-1501-IS.
- Bore holes with ± 1 mm tolerance.

Bracket ZL-1501-R (Sold Separately)



Item Code	Item Name
100-011-015	ZL-1501-R

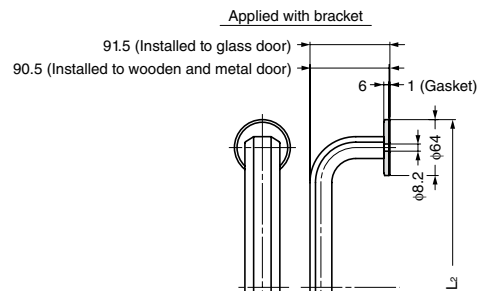
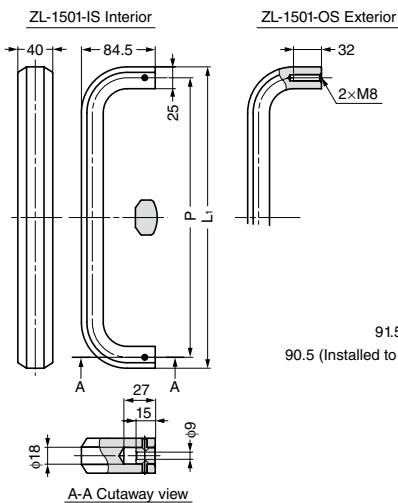

Material	Finish
Stainless Steel (SUS316)	Zwei L Finish

Item Code	Item Name	Type	L ₁	L ₂	P
100-177-010	ZL-1501-OS-320	Exterior	345	384	320
100-177-016	ZL-1501-IS-320	Interior	345	384	320
100-170-290	ZL-1501-WN-320	Back-to-Back	345	384	320
100-170-293	ZL-1501-WR-320	Back-to-Back with Base	345	384	320
100-177-011	ZL-1501-OS-640	Exterior	665	704	640
100-177-017	ZL-1501-IS-640	Interior	665	704	640
100-170-291	ZL-1501-WN-640	Back-to-Back	665	704	640
100-170-294	ZL-1501-WR-640	Back-to-Back with Base	665	704	640
100-177-012	ZL-1501-OS-960	Exterior	985	1024	960
100-177-018	ZL-1501-IS-960	Interior	985	1024	960
100-170-292	ZL-1501-WN-960	Back-to-Back	985	1024	960
100-170-295	ZL-1501-WR-960	Back-to-Back with Base	985	1024	960

Item Code	Item Name	Type	L ₁	L ₂	P
100-177-013	*ZL-1501-OS-1280	Exterior	1305	1344	1280
100-177-019	*ZL-1501-IS-1280	Interior	1305	1344	1280
100-170-250	*ZL-1501-WN-1280	Back-to-Back	1305	1344	1280
100-170-254	*ZL-1501-WR-1280	Back-to-Back with Base	1305	1344	1280
100-177-014	*ZL-1501-OS-1600	Exterior	1625	1664	1600
100-177-020	*ZL-1501-IS-1600	Interior	1625	1664	1600
100-170-252	*ZL-1501-WN-1600	Back-to-Back	1625	1664	1600
100-170-255	*ZL-1501-WR-1600	Back-to-Back with Base	1625	1664	1600
100-177-015	*ZL-1501-OS-1920	Exterior	1945	1984	1920
100-177-021	*ZL-1501-IS-1920	Interior	1945	1984	1920
100-170-253	*ZL-1501-WN-1920	Back-to-Back	1945	1984	1920
100-170-256	*ZL-1501-WR-1920	Back-to-Back with Base	1945	1984	1920

*Made to order.

Working Diagram		Door Thickness (mm)	Door Hole (mm)	Item Name	
Back-to-Back on Glass Door	With Base Plate		6 - 16	φ16	ZL-1501-WR
Back-to-Back on Wooden/Metal Frame Door	With Base Plate		25 - 45	φ9	ZL-1501-WR
	Without Base Plate		37 - 57	φ9	ZL-1501-WN
Single Use on Wooden/Metal Frame Door	With Base Plate		Screws not included. Base Plate (ZL-1501-R) sold separately	φ9	ZL-1501-OS ZL-1501-R
				-	ZL-1501-IS ZL-1501-R
	Without Base Plate			φ9	ZL-1501-OS
				-	ZL-1501-IS

*If door thickness exceeds recommended thickness, a longer bolt (not supplied) should be used.

Zwei L STAINLESS STEEL DOOR HANDLE



ZL-1502

HANDLES,
PULLS & KNOBS

STAINLESS STEEL DOOR HANDLE



Features

- Made of highly corrosion resistant SUS316
- Ultrapremium Zwei L finish. Zwei L finish: Using top class polishing technology, these products combine the elegance of Satin with the deep glow of a Mirror.
- Can be installed on both sides of glass, metal or wooden doors. Can also be installed on a single side of glass, wood or metal doors. Please refer to the door handle sets below.
- The ZL-1502 is generally installed with the circle bracket but can also be installed without it.
- Dual side handle sets use ZL-1502-WR and are attached by ZL-1502-OS (for the outside) and ZL-1502-IS (for the inside)

Remarks

- Screws are not included in ZL-1502-OS and ZL-1502-IS.
- Bore holes with ± 1 mm tolerance.

ZL-1502-OS Interior

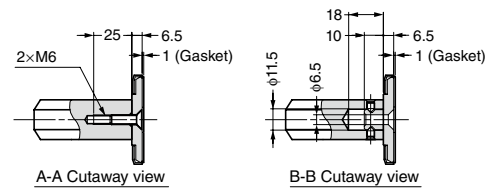
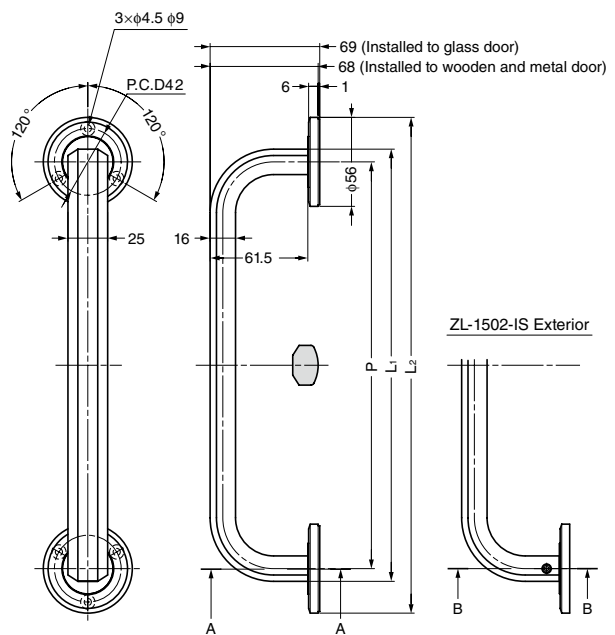

Item Code	Item Name	Type	Material	Finish	L ₁	L ₂	P
100-177-034	ZL-1502-OS-192	Exterior	Stainless Steel (SUS316)	Zwei L Finish	208	248	192
100-177-038	ZL-1502-IS-192	Interior	Stainless Steel (SUS316)	Zwei L Finish	208	248	192
100-170-296	ZL-1502-WR-192	Back-to-Back with Base	Stainless Steel (SUS316)	Zwei L Finish	208	248	192
100-177-035	ZL-1502-OS-320	Exterior	Stainless Steel (SUS316)	Zwei L Finish	336	376	320
100-177-039	ZL-1502-IS-320	Interior	Stainless Steel (SUS316)	Zwei L Finish	336	376	320
100-170-297	ZL-1502-WR-320	Back-to-Back with Base	Stainless Steel (SUS316)	Zwei L Finish	336	376	320
100-177-036	ZL-1502-OS-640	Exterior	Stainless Steel (SUS316)	Zwei L Finish	656	696	640
100-177-040	ZL-1502-IS-640	Interior	Stainless Steel (SUS316)	Zwei L Finish	656	696	640
100-170-298	ZL-1502-WR-640	Back-to-Back with Base	Stainless Steel (SUS316)	Zwei L Finish	656	696	640
100-177-037	ZL-1502-OS-960	Exterior	Stainless Steel (SUS316)	Zwei L Finish	976	1016	960
100-177-041	ZL-1502-IS-960	Interior	Stainless Steel (SUS316)	Zwei L Finish	976	1016	960
100-170-299	ZL-1502-WR-960	Back-to-Back with Base	Stainless Steel (SUS316)	Zwei L Finish	976	1016	960

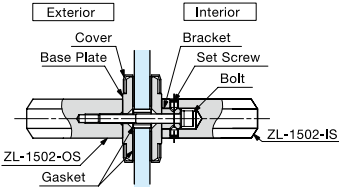
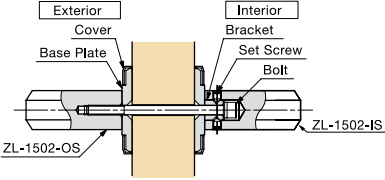
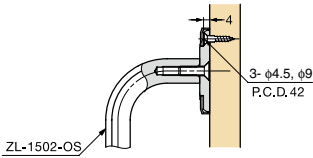
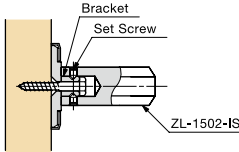
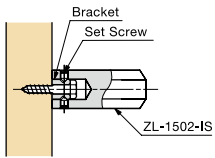
Working Diagram		Door Thickness (mm)	Door Hole (mm)	Item Name	
Back-to-Back on Glass Door	With Base Plate		6 - 12	φ12	ZL-1502-WR
	Without Base Plate		40 - 52	φ7	ZL-1502-WR
Back-to-Back on Wooden/Metal Frame Door	With Base Plate		38 - 50	φ7	ZL-1502-WR
	Without Base Plate				
Single Use on Wooden/Metal Frame Door	With Base Plate			-	ZL-1502-OS
				φ7	ZL-1502-OS
	Without Base Plate			-	ZL-1502-IS
				φ7	ZL-1502-OS
				-	ZL-1502-IS

*If door thickness exceeds recommended thickness, a longer bolt (not supplied) should be used.

Zwei L STAINLESS STEEL DOOR HANDLE

STAINLESS
316
STEEL

ZL-1506

HANDLES,
PULLS & KNOBS

STAINLESS STEEL DOOR HANDLE



Features

- Made of highly corrosion resistant SUS316
- Ultrapremium Zwei L finish. Zwei L finish: Using top class polishing technology, these products combine the elegance of Satin with the deep glow of a Mirror.
- Can be installed on both sides of glass, metal or wooden doors. Can also be installed on a single side of glass, wood or metal doors.
- Please refer to the door handle set list below to choose a type appropriate for your use.
- The ZL-1502 is generally installed with a circle bracket but can also be installed without it.
- Dual side handle sets use ZL-1506-WR and are attached by ZL-1506-OS (for the outside) and ZL-1506-IS (for the inside)

Remarks

- Screws are not included to ZL-1506-OS and ZL-1506-IS.
- Bore holes with ± 1 mm tolerance.

Parts Included

Hex key 5

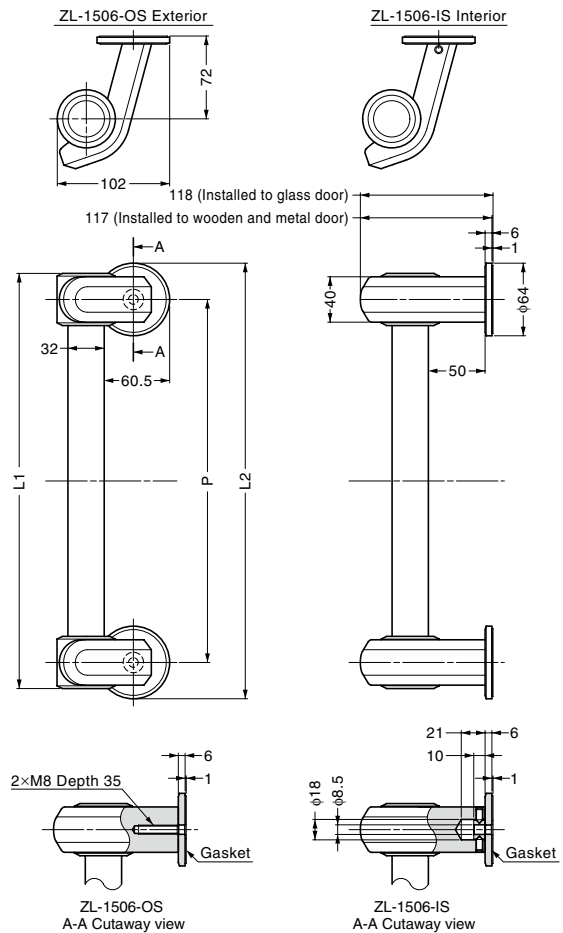

Item Code	Item Name	Type	Material	Finish	L ₁	L ₂	P
100-022-172	ZL-1506-OS-192	Exterior	Stainless Steel (SUS316)	Zwei L Finish	238	256	192
100-022-173	ZL-1506-IS-192	Interior	Stainless Steel (SUS316)	Zwei L Finish	238	256	192
100-022-174	ZL-1506-WR-192	Back-to-Back with Base	Stainless Steel (SUS316)	Zwei L Finish	238	256	192
100-022-175	ZL-1506-OS-320	Exterior	Stainless Steel (SUS316)	Zwei L Finish	366	384	320
100-022-176	ZL-1506-IS-320	Interior	Stainless Steel (SUS316)	Zwei L Finish	366	384	320
100-022-177	ZL-1506-WR-320	Back-to-Back with Base	Stainless Steel (SUS316)	Zwei L Finish	366	384	320
100-022-178	ZL-1506-OS-640	Exterior	Stainless Steel (SUS316)	Zwei L Finish	686	704	640
100-022-179	ZL-1506-IS-640	Interior	Stainless Steel (SUS316)	Zwei L Finish	686	704	640
100-022-180	ZL-1506-WR-640	Back-to-Back with Base	Stainless Steel (SUS316)	Zwei L Finish	686	704	640
100-022-181	ZL-1506-OS-960	Exterior	Stainless Steel (SUS316)	Zwei L Finish	1006	1024	960
100-022-182	ZL-1506-IS-960	Interior	Stainless Steel (SUS316)	Zwei L Finish	1006	1024	960
100-022-183	ZL-1506-WR-960	Back-to-Back with Base	Stainless Steel (SUS316)	Zwei L Finish	1006	1024	960

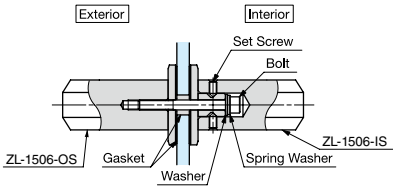
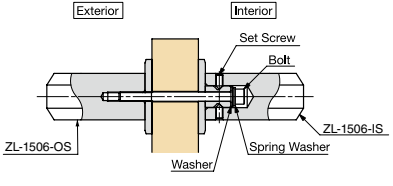
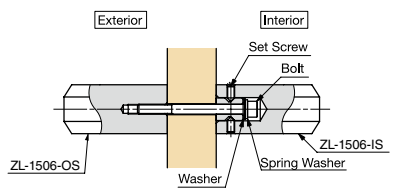
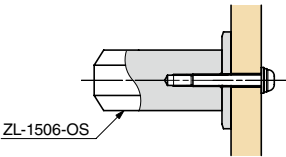
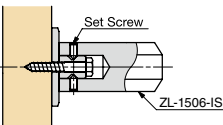
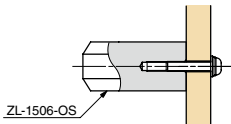
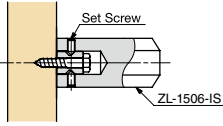
Working Diagram		Door Thickness (mm)	Door Hole (mm)	Item Name	
Back-to-Back on Glass Door	With Base Plate		6 - 15	φ16	ZL-1506-WR
Back-to-Back on Wooden/Metal Frame Door	With Base Plate		25 - 45	φ9	ZL-1506-WR
	Without Base Plate		37 - 57	φ9	ZL-1506-WR
Single Use on Wooden/Metal Frame Door	With Base Plate		Screws not included.	φ9	ZL-1506-OS
				-	ZL-1506-IS
	Without Base Plate			φ9	ZL-1506-OS
				-	ZL-1506-IS

*If door thickness exceeds recommended thickness, a longer bolt (not supplied) should be used.

STAINLESS STEEL DOOR HANDLE

STAINLESS
316
STEEL

MP

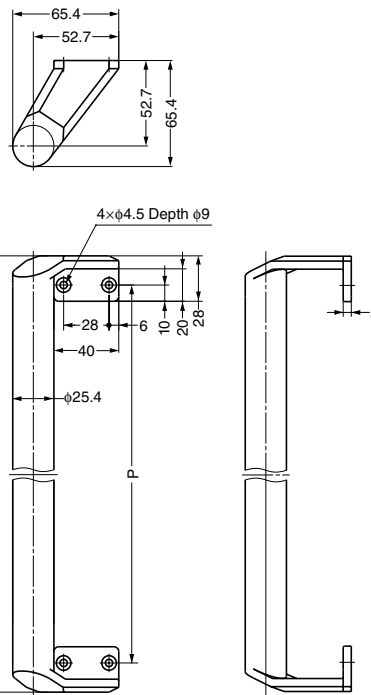

Features

- Simple design which can be installed from the front
- Does not have any brackets or joints, protecting clothes from getting caught inside when passing.
- Possible to customize the length. For questions about lot size and options, please contact us.

Recommended Screw

- Countersunk head screw M4
- Countersunk head tapping screw 4
- Countersunk head wood screw 4.1

Item Code	Item Name	Material	Finish	L	P	Weight	Box	Carton
100-010-500	MP- 500	Stainless Steel (SUS316)	Mirror	500	464	1000 g	2 pcs	20 pcs
100-010-501	MP- 750	Stainless Steel (SUS316)	Mirror	750	714	1300 g	2 pcs	16 pcs
100-010-502	MP-1000	Stainless Steel (SUS316)	Mirror	1000	964	1600 g	2 pcs	12 pcs

STAINLESS STEEL DOOR HANDLE

STAINLESS
303
STEELSTAINLESS
304
STEEL

RH-760

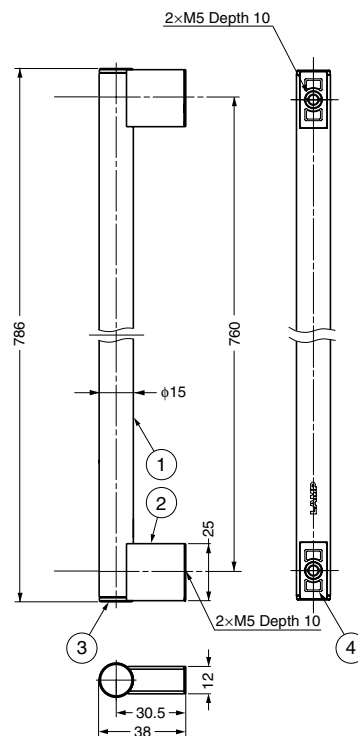
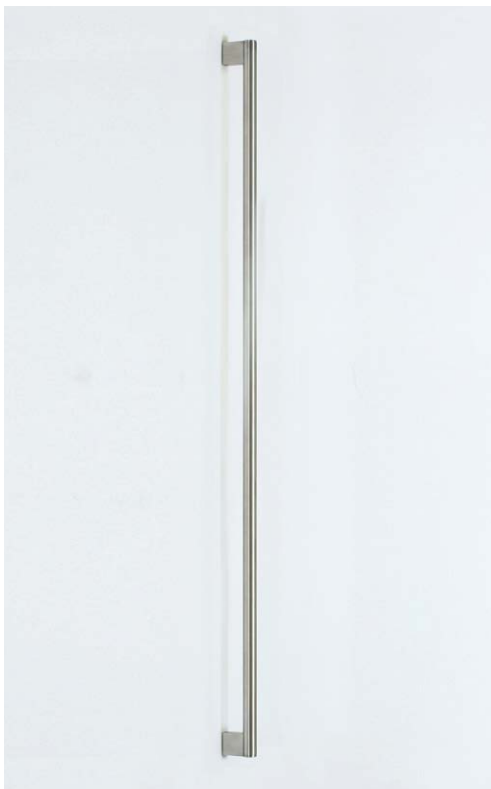

Features

- Reduced profile handle with a simple design made from Stainless Steel.
- Possible to customize the length. For questions about lot size and options, please contact us.

Recommended Screw

M5 screw

No.	Part Name	Material	Finish/Colour
①	Body	Stainless Steel (SUS304)	Satin
②	Stem	Stainless Steel (SUS304)	Satin
③	End Cap	Stainless Steel (SUS303)	Satin
④	Spacer	Polypropylene (PP)	Plain

Item Code	Item Name	Weight	Box
100-010-341	RH-760	340 g	20 pcs

STAINLESS STEEL DOOR HANDLE



SSH

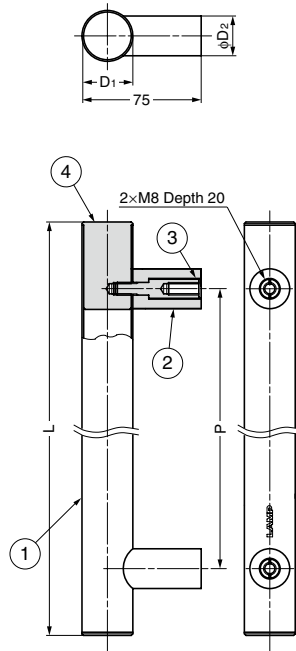

Features

- Simple design made from Stainless Steel.
- Possible to customize the length. For questions about lot size and options, please contact us.

Recommended Screw

M8

No.	Part Name	Material	Finish
①	Body	Stainless Steel (SUS304)	Satin
②	Stem	Stainless Steel (SUS304)	Satin
③	Screw	Stainless Steel (SUS304)	Satin
④	Cover	Stainless Steel (SUS304)	Satin

Item Code	Item Name	L	P	D ₁	D ₂	Weight	Carton
100-181-413	SSH-2540	400	316	25	19	665 g	10 pcs
100-181-414	SSH-2560	600	516	25	19	750 g	10 pcs
100-181-415	SSH-2580	800	716	25	19	840 g	10 pcs
100-181-416	SSH-3240	400	316	32	25	1175 g	5 pcs
100-181-417	SSH-3260	600	516	32	25	1290 g	5 pcs
100-181-418	SSH-3280	800	716	32	25	1400 g	5 pcs

ALUMINIUM DOOR HANDLE

SOR

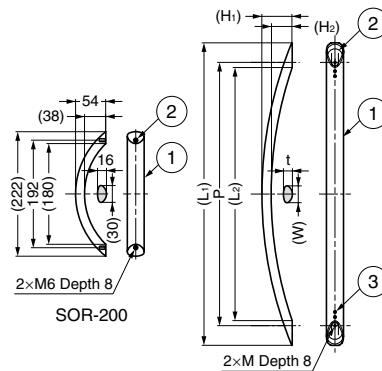
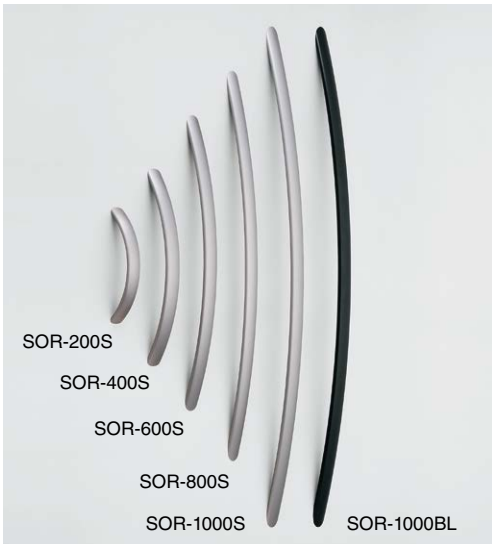

Features

- Flowing curves that adapt gracefully to any surface.
- Other handle sizes are available. Please contact us for lot size and prices.

Recommended Screw

M6, M8

No.	Part Name	Material
①	Body	Aluminium Alloy
②	Insert	Stainless Steel (SCS13)
③	Screw	Stainless Steel

Item Code	Item Name	Finish	L ₁	L ₂	P	H ₁	H ₂	W	t	M	Weight	Carton	
100-028-297	SOR-200S	Stainless Steel/Anodized	As Above									228 g	50 pcs
100-028-298	SOR-200BL	Black/Anodized	As Above									228 g	50 pcs
100-010-961	SOR-400S	Stainless Steel/Anodized	390	323	335	60	42	34	18	M6	385 g	30 pcs	
100-010-963	SOR-400BL	Black/Anodized	390	323	335	60	42	34	18	M6	385 g	30 pcs	
100-010-962	SOR-600S	Stainless Steel/Anodized	600	502	522	60	42	34	18	M6	495 g	20 pcs	
100-010-964	SOR-600BL	Black/Anodized	600	502	522	60	42	34	18	M6	495 g	20 pcs	
100-010-960	SOR-800S	Stainless Steel/Anodized	816	686	710	60	42	34	18	M8	605 g	15 pcs	
100-010-965	SOR-800BL	Black/Anodized	816	686	710	60	42	34	18	M8	605 g	15 pcs	
100-028-299	SOR-1000S	Stainless Steel/Anodized	1090	939.8	975	80	59.8	38	20.2	M8	1647 g	8 pcs	
100-028-300	SOR-1000BL	Black/Anodized	1090	939.8	975	80	59.8	38	20.2	M8	1647 g	8 pcs	



DESIGN DOOR HANDLE

INSTRUCTION SUS MDH



Features

- Made from the combination of brackets and a pipe. Numerous combinations are possible.
- There are two types of brackets, both a straight type and an offset type.
- The pipe comes in the choice of two materials: stainless steel or carbon fiber reinforced polymer (CFRP).
- There are 5 different lengths available but the pipes can also be adjusted to different lengths by cutting.
- The CFRP pipe has been specially treated to prevent color change from UV rays.
- CFRP is used frequently in the airline industry due to its strength and lightweight. It can also help reduce the weight placed on frames. CFRP has a delicate mesh like appearance, providing a feeling of luxury.
- Also possible to purchase pieces of pipe without the bracket.

Remarks

- Brackets and pipes have separate item numbers. Please order together by indicating each specification.
- Bracket is sold in pairs.

How to Install

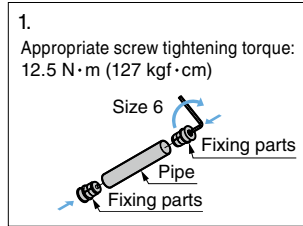

Insert the fixing parts (attached to the bracket) into both ends of the pipe until their flanges contact the pipe ends, and then tighten the screws with a hex key size 6 (not included).

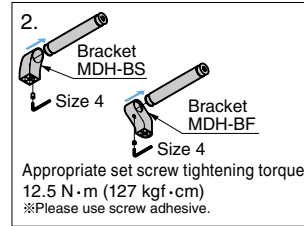

Insert one bracket into the pipe, and tighten the set screws (attached to the bracket) with a hex key size 4 (not included).

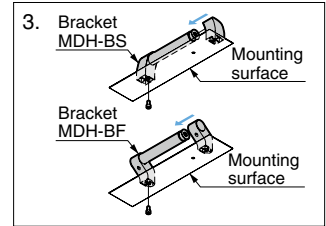

Install one bracket to the mounting surface with M8 screws (not included). Install the other bracket in the same procedure after being preliminarily assembled.

Bracket



Fixing Parts

Attached to the bracket



Installation of Bracket and Pipe

Bracket MDH-BS (Straight type)

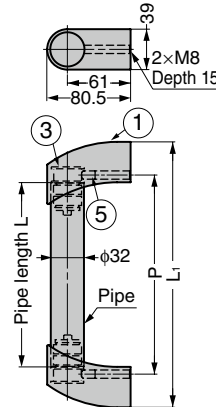

Bracket MDH-BF (Offset type)

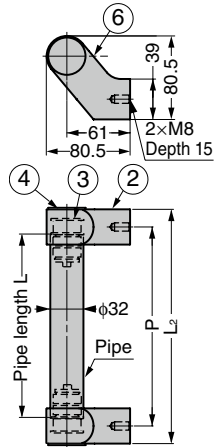

Bracket

Item Code	Item Name	Type	Parts	Weight (g)	Box (sets)	Carton (sets)
100-022-158	MDH-BS	Straight	①③⑤ (Each 2 pcs)	1010	1	1
100-022-159	MDH-BF	Offset	②③④⑥ (Each 2 pcs)	1122	1	1

No.	Part Name	Material	Finish/Colour
①	Bracket (Straight)	Zinc Alloy (ZDC)	Matte Chrome
②	Bracket (Offset)		
③	Fixing Parts		Plain
④	Cover	POM	Black
⑤	Hexagon Socket Set Screw M8x15	Stainless Steel	Plain
⑥	Hexagon Socket Set Screw M8x8		

Pipe

Item Code	Item Name	Material	Finish	Pipe Length L	L ₁	L ₂	P	Pipe Thickness	Load capacity N	Load capacity kgf	Weight (g)	Box (pcs)	Carton (pcs)
100-022-161	MDH-PS192	Stainless Steel (SUS304)	Satin	177	256	226	192	2	490	50	384	1	10
100-022-162	MDH-PS350			335	414	384	350				727	1	10
100-022-163	MDH-PS500			485	564	534	500				1050	1	10
100-022-164	MDH-PS800			785	864	834	800				1700	1	10
100-022-165	MDH-PS1200			1185	1264	1234	1200				2570	1	10
100-022-166	MDH-PC192	Carbon Fiber Reinforced Polymer (CFRP)	Paint/Clear	177	256	226	192	2.5	490	50	70	1	1
100-022-167	MDH-PC350			335	414	384	350				132	1	1
100-022-168	MDH-PC500			485	564	534	500				191	1	1
100-022-169	MDH-PC800			785	864	834	800				309	1	1
100-022-170	MDH-PC1200			1185	1264	1234	1200				467	1	1

TAMAZUSA DOOR HANDLE



DTM-B

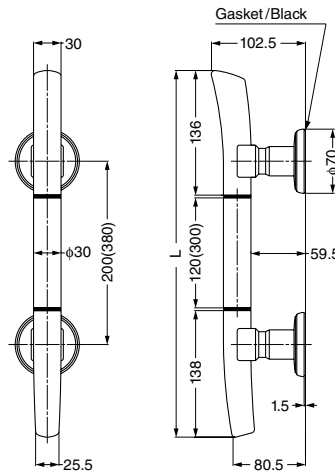

Features

- This interior concept is inspired by the splendor and traditional beauty of 16th century Japanese culture. By transplanting these designs into the modern world, the "Tamazusa" series was born. The series emulates "Ryusui" flowing water Japanese design and has gentle soft lines, providing a comforting and desirable aesthetic.
- The Tamazusa series has knobs, handles and lever handles.
- This door handle is covered in 24k gold plating.

Parts Included

Hexagon socket set screw M6x8 (SUS)

Installation

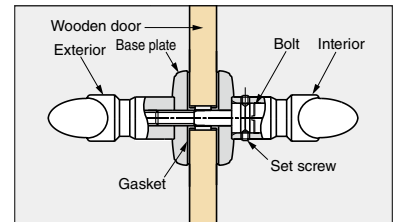

Item Code	Item Name	L	Material	Finish	Door Thickness	Holes	Box
100-173-776	DTM-B400GA	400	Brass	24K Gold Plating (Body), Black Nickel (Ring)	Wooden Door: 36 - 50, Glass Door: 10, 12, 15	φ17	2 pcs/set
100-173-775	DTM-B580GA	580	Brass	24K Gold Plating (Body), Black Nickel (Ring)	Wooden Door: 36 - 50, Glass Door: 10, 12, 15	φ17	2 pcs/set

HANDLES,
PULLS & KNOBS

DOOR HANDLE

たまづき

Tamazusa is a range of handles inspired by the art and architecture of the Momoyama period in Japanese history.

When the 16th overlord Nobunaga Oda set about the bloody process of unifying Japan he built a fabulous castle near Kyoto. Until the Momoyama period Castles were gloomy military structures but Azuchi castle was a glittering celebration of power and art. The intention was to impress and intimidate and the fusion of art and architecture defined the era.



TMT (P.78)

Sugatsune has taken the delicate curves of the Momoyama period and fashioned a series of opulent 24 carat gold plated handles and pulls that express the beauty of Momoyama in a contemporary voice.



TMH (P.36)



Without base plate



Zwei L is the flagship brand of Sugatsune and represents premium Japanese hardware quality.
Zwei L stands for "Zwei Lichten" in German: a dual highlight of mirror finish and lustrous satin on a faceted profile.

Manufactured from solid billets of the finest quality 316 stainless steel,

Zwei L brings the space luxury and dazzles your eyes.

Zwei L®



Video Link



Zwei L STAINLESS STEEL DOOR KNOB



ZL-1503



Features

- Made of highly corrosion resistant SUS316
- Ultrapremium Zwei L finish. Zwei L finish: Using top class polishing technology, these products combine the elegance of Satin with the deep glow of a Mirror.

Parts Included

- Bolt set for door knob
- Allen key
- Gasket

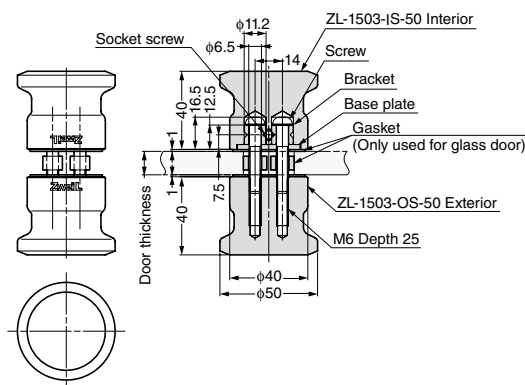

Cut Out Dimensions (for wood)

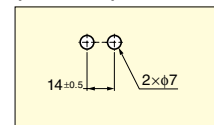

Cut Out Dimensions (for glass)

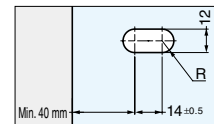

Item Code	Item Name	Type	Material	Finish	Door Thickness	Weight
100-170-788	ZL-1503-IS-50	Interior Knob	Stainless Steel (SUS316)	Zwei L Finish	Wooden/Metal Frame: 36 - 48, Glass: 6, 8, 10, 12	413 g
100-170-787	ZL-1503-OS-50	Exterior Knob	Stainless Steel (SUS316)	Zwei L Finish	Wooden/Metal Frame: 36 - 48, Glass: 6, 8, 10, 12	507 g
100-011-032	ZL-1503-WN-50	Back-to-Back Knob	Stainless Steel (SUS316)	Zwei L Finish	Wooden/Metal Frame: 36 - 48, Glass: 6, 8, 10, 12	1015 g

Zwei L STAINLESS STEEL DOOR KNOB



ZL-2502



Features

- Made of highly corrosion resistant SUS316
- Ultrapremium Zwei L finish. Zwei L finish: Using top class polishing technology, these products combine the elegance of Satin with the deep glow of a Mirror.
- Installed using UV curing

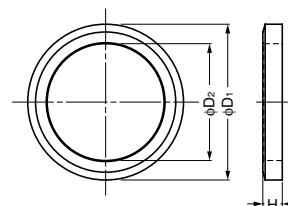

Item Code	Item Name	Material	Finish	D ₁	D ₂	H	Weight
100-010-972	ZL-2502-56	Stainless Steel (SUS316)	Zwei L Finish	56	38	6	68 g
100-010-973	ZL-2502-80	Stainless Steel (SUS316)	Zwei L Finish	80	53	10	222 g

Zwei L STAINLESS STEEL DOOR KNOB



ZL-1504



- Features**
Superior finish of Mirror/Satin.
- Parts Included**
- Bolt set for door knob
 - Allen key
 - Gasket

Cut Out Dimensions (for wood)

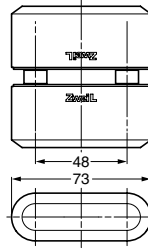
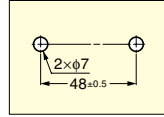

Cut Out Dimensions (for glass)

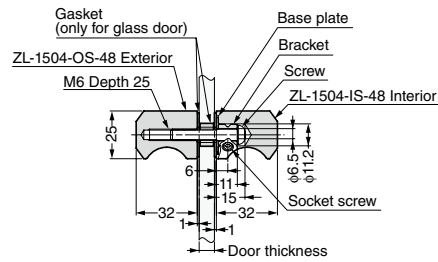
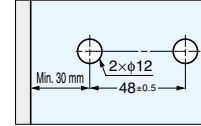

Item Code	Item Name	Type	Material	Finish	Door Thickness	Weight
100-170-785	ZL-1504-IS-48	Interior Knob	Stainless Steel (SUS316)	Zwei L Finish	Wooden/Metal Frame: 36 - 48, Glass: 6, 8, 10, 12	432 g
100-170-784	ZL-1504-OS-48	Exterior Knob	Stainless Steel (SUS316)	Zwei L Finish	Wooden/Metal Frame: 36 - 48, Glass: 6, 8, 10, 12	462 g
100-011-031	ZL-1504-WN-48	Back-to-Back Knob	Stainless Steel (SUS316)	Zwei L Finish	Wooden/Metal Frame: 36 - 48, Glass: 6, 8, 10, 12	989 g

Zwei L STAINLESS STEEL DOOR KNOB



ZL-1505



- Features**
Superior finish of Mirror/Satin.
- Parts Included**
- ZL-1505-IS: Bracket
Washer
Hexagon socket head screw M5x8
 - ZL-1505-OS: Zwei L screw M5x28, Gasket(1pc)
 - ZL-1505-WN: Bolt set ZL-1505-B, Gasket(1pc)

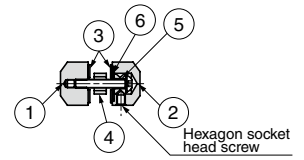

Cut Out Dimensions (for wood)

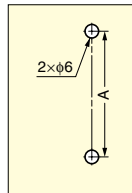

Cut Out Dimensions (for glass)

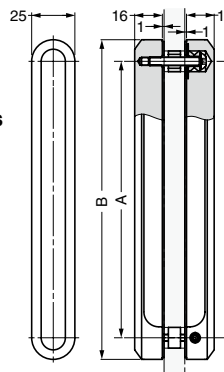
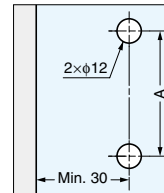

Item Code	Item Name	Type	Material	Finish	A	B	Weight
100-011-026	ZL-1505-IS-160	Interior Knob	Stainless Steel (SUS316)	Zwei L Finish	160	185	563 g
100-011-028	ZL-1505-IS-320	Interior Knob	Stainless Steel (SUS316)	Zwei L Finish	320	345	1023 g
100-011-025	ZL-1505-OS-160	Exterior Knob	Stainless Steel (SUS316)	Zwei L Finish	160	185	580 g
100-011-027	ZL-1505-OS-320	Exterior Knob	Stainless Steel (SUS316)	Zwei L Finish	320	345	1052 g
100-010-433	ZL-1505-WN-160	Back-to-Back Knob	Stainless Steel (SUS316)	Zwei L Finish	160	185	1177 g
100-010-434	ZL-1505-WN-320	Back-to-Back Knob	Stainless Steel (SUS316)	Zwei L Finish	320	345	2109 g

No.	Part Name	Material
①	ZL-1505-OS (Exterior)	Stainless Steel (SUS316)
②	ZL-1505-IS (Interior)	Stainless Steel (SUS316)
③	Gasket	Elastomer (TPE)
④	Rubber Ring	Chloroprene Rubber (CR)
⑤	Bracket	Stainless Steel (SUS316)
⑥	Washer	Stainless Steel (SUS316)

Bolt Set for Back-to-back Installation

Item Code	Item Name
100-011-029	ZL-1505-B

Part Name	Door	Material	Qty	Door Thickness
Hexagon Socket Button Head Screw M5x60	Wooden/Metal Frame	Stainless Steel	2 pcs	40 - 46
Hexagon Socket Button Head Screw M5x30	Glass	Stainless Steel	2 pcs	8, 10, 12
Hex Key	-	Steel	1 pc	-
Rubber Ring	Glass	Chloroprene Rubber (CR)	2 pcs	-



Zwei L STAINLESS STEEL KNOB



ZL-1909

HANDLES,
PULLS & KNOBS

FOR GLASS DOORS

STAINLESS STEEL KNOB



Features

- Made of highly corrosion resistant SUS316
- Ultrapremium Zwei L finish. Zwei L finish: Using top class polishing technology, these products combine the elegance of Satin with the deep glow of a Mirror.
- Can be used on either wood or tempered glass.
- XL-2105 is a hook with the same type of design.

Parts Included

- For wooden doors : 16 - 23 mm : Screw M4x28 (SUS)
- For glass doors : 4, 5, 6 mm : Screw M4x16 (SUS)
- Gasket

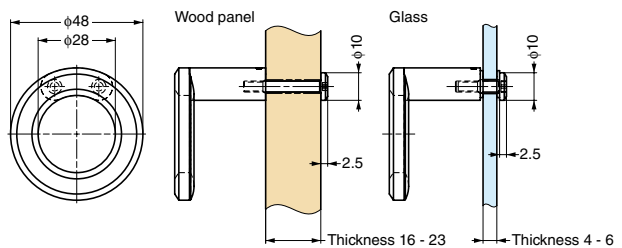
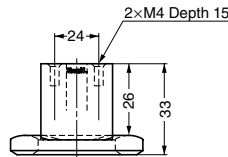

Cut Out Dimensions

Wooden doors

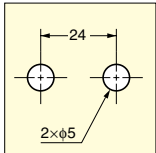

Glass doors

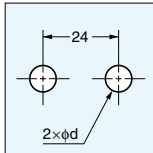

Thickness 4, 5 : d=5
Thickness 6 : d=6

Item Code	Item Name	Material	Finish	Weight
100-022-171	ZL-1909	Stainless Steel (SUS316)	Zwei L Finish	97 g

Zwei L STAINLESS STEEL KNOB



ZL-1907-24



Features

- Made of highly corrosion resistant SUS316
- Ultrapremium Zwei L finish. Zwei L finish: Using top class polishing technology, these products combine the elegance of Satin with the deep glow of a Mirror.
- Can be used on either wood or tempered glass.
- XL-1504 is a door knob with the same type of design.

Parts Included

- For wooden doors : 16 - 23 mm : Screw M4x28 (SUS)
- For glass doors : 4, 5, 6 mm : Screw M4x16 (SUS)
- Gasket

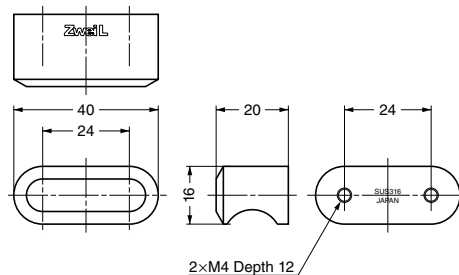

Cut Out Dimensions

Wooden doors

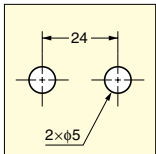

Glass doors

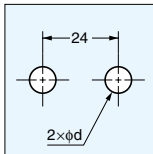

Thickness 4, 5 : d=5
Thickness 6 : d=6

Item Code	Item Name	Material	Finish	Weight
100-011-016	ZL-1907-24	Stainless Steel (SUS316)	Zwei L Finish	78 g

Zwei L STAINLESS STEEL KNOB



ZL-1906



Features

- Made of highly corrosion resistant SUS316
- Ultrapremium Zwei L finish. Zwei L finish: Using top class polishing technology, these products combine the elegance of Satin with the deep glow of a Mirror.
- Can be used on either wood or tempered glass.
- ZL-1503 is a door knob with the same type of design.

Parts Included

- For wooden doors : 16 - 23 mm : Screw M4x28 (SUS)
- For glass doors : 4, 5, 6 mm : Screw M4x16 (SUS)
- Gasket

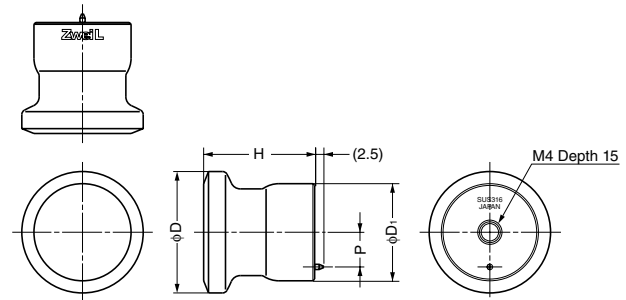

Cut Out Dimensions

Wooden doors

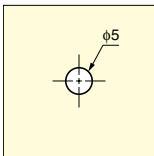

Glass doors

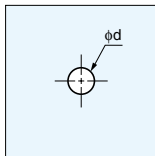

Thickness 4, 5 : d=5
Thickness 6 : d=6

Item Code	Item Name	Material	Finish	H	D	D ₁	P	Weight
100-011-019	ZL-1906-20	Stainless Steel (SUS316)	Zwei L Finish	20	20	16	5	32 g
100-011-018	ZL-1906-28	Stainless Steel (SUS316)	Zwei L Finish	26	28	22.5	8	83 g
100-011-017	ZL-1906-36	Stainless Steel (SUS316)	Zwei L Finish	32	36	28	10	165 g

DUAL-SIDED KNOB FOR GLASS



GT-40CR



Features

- Glass knob recommended for use in places like showers and bathrooms.

Parts Included

- PVC washers
- Screw M5 (SUS)

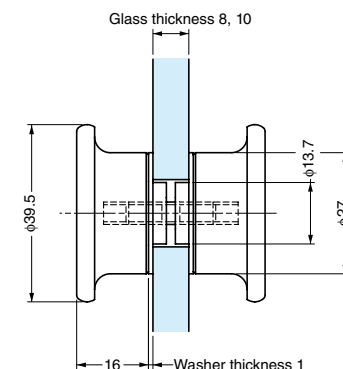

Cut Out Dimension

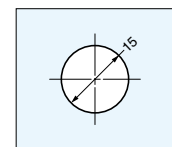

Installation

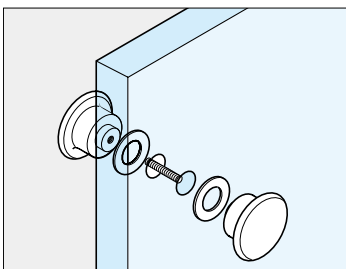

Item Code	Item Name	Material	Finish	Glass Thickness	Weight	Box	Carton
100-019-767	GT-40CR	Brass	Chrome	8, 10	215 g	6 pcs	48 pcs

STAINLESS STEEL SLIDING DOOR HANDLE



DSI-4251



DSI-3250

STAINLESS STEEL SLIDING DOOR HANDLE

STAINLESS
304
STEEL

DSI-4253



Features

- Contemporary handle design that can be accessed from door front, back, or edge.
- Requires adhesive for installation. (Such as 2-part epoxy, not supplied.)

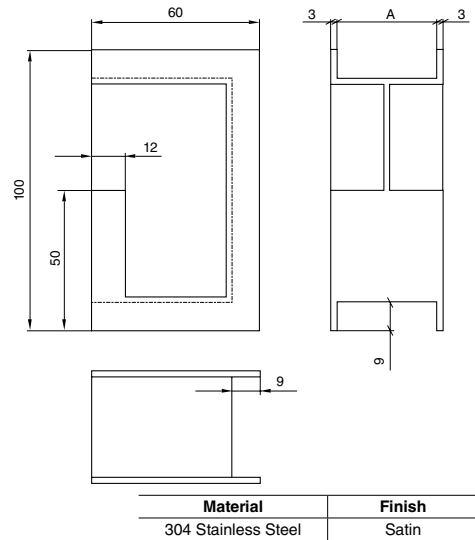

Item Code	Item Name	A	Weight	Box	Carton
-	DSI-4253-35	35	495 g	1 pc	10 pcs
-	DSI-4253-38	38	506 g		
-	DSI-4253-40	40	515 g		
-	DSI-4253-43	43	530 g		
-	DSI-4253-45	44.5	545 g		

STAINLESS STEEL SLIDING DOOR HANDLE

STAINLESS
304
STEEL

DSI-3250



Features

- Contemporary handle design that can be accessed from door front, back, or edge.
- Requires adhesive for installation. (Such as 2-part epoxy, not supplied.)

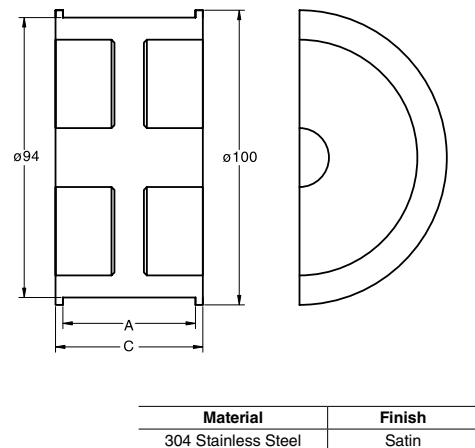

Item Code	Item Name	C	A	Weight	Box	Carton
-	DSI-3250-12	16	12	280 g	1 pc	10 pcs
-	DSI-3250-35	39	35	440 g		
-	DSI-3250-45	49	45	550 g		
-	DSI-3250-50	54	50	670 g		

STAINLESS STEEL SLIDING DOOR HANDLE

STAINLESS
304
STEEL

DSI-4251



Features

- Contemporary handle design that can be accessed from door front, back, or edge.
- Requires adhesive for installation. (Such as 2-part epoxy, not supplied.)

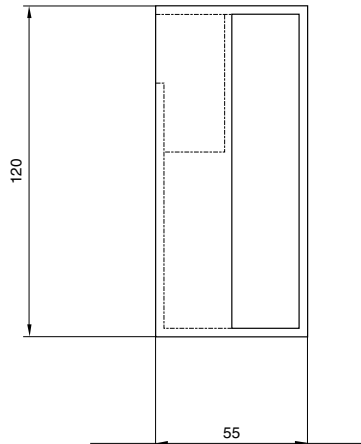
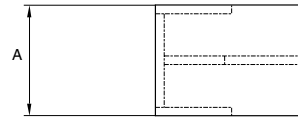

Item Code	Item Name	A	Weight	Box	Carton
-	DSI-4251-35	35	490 g	1 pc	10 pcs
-	DSI-4251-38	38	515 g		
-	DSI-4251-40	40	530 g		
-	DSI-4251-43	43	550 g		
-	DSI-4251-45	44.5	570 g		
-	DSI-4251-50	50	590 g		

Material	Finish
304 Stainless Steel	Satin

STAINLESS STEEL DOOR HANDLE

STAINLESS
304
STEEL

DSI-3330

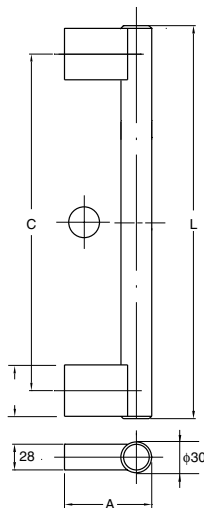

Features

- For use with DSI mounting kits (Sold separately, P.108).
- Please specify Interior/Exterior type when ordering:
 - Posts for Exterior handles are threaded to accept screws.
 - Posts for Interior handles have set screws for DSI mounting kits.
- Similar style to I1020 cabinet handles (P.29).

Material	Finish
304 Stainless Steel	Satin

Item Code		Item Name		L	C	A	Weight		Box	Carton
Interior	Exterior	Interior	Exterior				Interior	Exterior		
-	-	DSI-3330-30-30I	DSI-3330-30-30E	320	300	90	1.48 kg	1.56 kg	1 pc	10 pcs
-	-	DSI-3330-30-50I	DSI-3330-30-50E	520	500		1.70 kg	1.70 kg		



DSI-2000

STAINLESS STEEL DOOR HANDLE

HANDLES,
PULLS & KNOBS

STAINLESS STEEL DOOR HANDLE



Features

- For use with DSI mounting kits (Sold separately, P.108).
- Please specify Interior/Exterior type when ordering:
 - Posts for Exterior handles are threaded to accept screws.
 - Posts for Interior handles have set screws for DSI mounting kits.
- Similar style to I1014 cabinet handles (P.29).

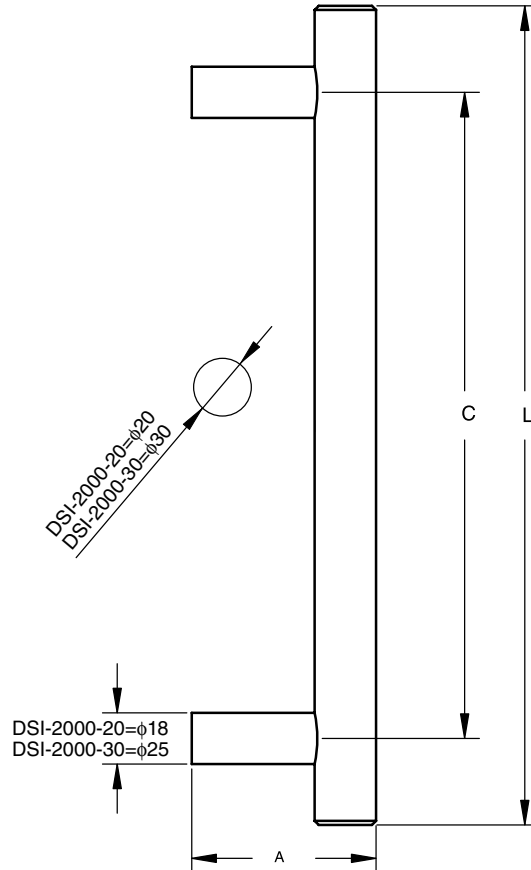

Material	Finish
304 Stainless Steel	Satin

Item Code		Item Name		L	C	A	Weight		Box	Carton
Interior	Exterior	Interior	Exterior				Interior	Exterior		
-	-	DSI-2000-20-20I	DSI-2000-20-20E	300	200	65	0.88 kg	0.88 kg	1 pc	10 pcs
-	-	DSI-2000-20-25I	DSI-2000-20-25E	400	250		1.11 kg	1.11 kg		
-	-	DSI-2000-20-30I	DSI-2000-20-30E	450	300		1.23 kg	1.25 kg		
-	-	DSI-2000-20-50I	DSI-2000-20-50E	700	500		0.47 kg	0.54 kg		

Item Code		Item Name		L	C	A	Weight		Box	Carton
Interior	Exterior	Interior	Exterior				Interior	Exterior		
-	-	DSI-2000-30-25I	DSI-2000-30-25E	550	250	90	1.34 kg	1.11 kg	1 pc	10 pcs
-	-	DSI-2000-30-35I	DSI-2000-30-35E	650	350		1.22 kg	1.20 kg		
-	-	DSI-2000-30-45I	DSI-2000-30-45E	750	450		1.34 kg	1.29 kg		
-	-	DSI-2000-30-60I	DSI-2000-30-60E	900	600		1.50 kg	1.50 kg		



STAINLESS STEEL DOOR HANDLE



DSI-3310

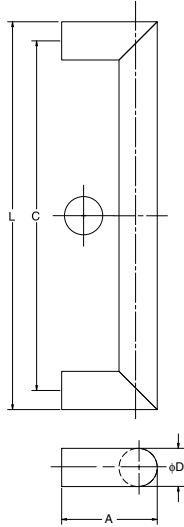

Features

- For use with DSI mounting kits (Sold separately, P.108).
- Please specify Interior/Exterior type when ordering:
 - Posts for Exterior handles are threaded to accept screws.
 - Posts for Interior handles have set screws for DSI mounting kits.
- Similar style to DIH series cabinet handles (P.29).

Material	Finish
304 Stainless Steel	Satin

Item Code		Item Name		D	L	C	A	Weight		Box	Carton
Interior	Exterior	Interior	Exterior					Interior	Exterior		
-	-	DSI-3310-15-15I	DSI-3310-15-15E	15	165	150	55	0.32 kg	0.32 kg	1 pc	10 pcs
-	-	DSI-3310-15-20I	DSI-3310-15-20E		215	200		0.38 kg	0.40 kg		
-	-	DSI-3310-15-30I	DSI-3310-15-30E		315	300		0.52 kg	0.54 kg		
-	-	DSI-3310-20-20I	DSI-3310-20-20E	20	220	200	65	0.16 kg	0.18 kg		
-	-	DSI-3310-20-25I	DSI-3310-20-25E		270	250		0.18 kg	0.20 kg		
-	-	DSI-3310-20-30I	DSI-3310-20-30E		320	300		0.20 kg	0.23 kg		
-	-	DSI-3310-30-25I	DSI-3310-30-25E	30	280	250	90	0.48 kg	0.48 kg		
-	-	DSI-3310-30-30I	DSI-3310-30-30E		330	300		0.52 kg	0.52 kg		
-	-	DSI-3310-30-35I	DSI-3310-30-35E		380	350		0.59 kg	0.57 kg		
-	-	DSI-3310-30-60I	DSI-3310-30-60E		630	600		0.64 kg	0.64 kg		

STAINLESS STEEL DOOR HANDLE



DSI-4400

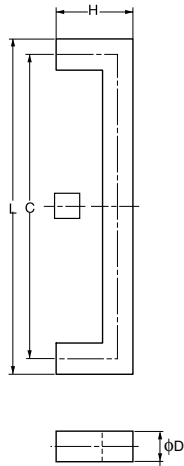

Features

- For use with DSI mounting kits (Sold separately, P.108).
- Please specify Interior/Exterior type when ordering:
 - Posts for Exterior handles are threaded to accept screws.
 - Posts for Interior handles have set screws for DSI mounting kits.
- Similar style to KPH series cabinet handles (P.26).

Material	Finish
304 Stainless Steel	Satin

Item Code		Item Name		D	L	C	H	Weight		Box	Carton
Interior	Exterior	Interior	Exterior					Interior	Exterior		
-	-	DSI-4400-15-15I	DSI-4400-15-15E	15	165	150	55	0.41 kg	0.42 kg	1 pc	10 pcs
-	-	DSI-4400-15-20I	DSI-4400-15-20E		215	200		0.48 kg	0.50 kg		
-	-	DSI-4400-15-30I	DSI-4400-15-30E		315	300		0.67 kg	0.68 kg		
-	-	DSI-4400-20-20I	DSI-4400-20-20E	20	220	200	65	0.18 kg	0.23 kg		
-	-	DSI-4400-20-25I	DSI-4400-20-25E		270	250		0.22 kg	0.24 kg		
-	-	DSI-4400-20-30I	DSI-4400-20-30E		320	300		0.26 kg	0.26 kg		
-	-	DSI-4400-30-25I	DSI-4400-30-25E	30	280	250	90	0.56 kg	0.59 kg		
-	-	DSI-4400-30-30I	DSI-4400-30-30E		330	300		0.51 kg	0.50 kg		
-	-	DSI-4400-30-35I	DSI-4400-30-35E		380	350		0.70 kg	0.57 kg		
-	-	DSI-4400-30-60I	DSI-4400-30-60E		630	600		1.10 kg	1.10 kg		



STAINLESS STEEL DOOR HANDLE



DSI-1630

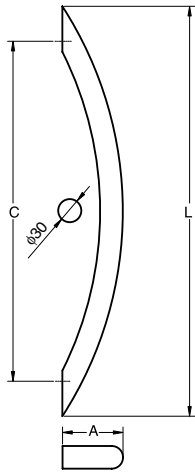

Features

- For use with DSI mounting kits (Sold separately, below).
- Please specify Interior/Exterior type when ordering:
 - Posts for Exterior handles are threaded to accept screws.
 - Posts for Interior handles have set screws for DSI mounting kits.
- Similar style to 30 series cabinet handles (P.27).

Material	Finish
304 Stainless Steel	Satin

Item Code		Item Name		L	C	A	Weight	Box	Carton
Interior	Exterior	Interior	Exterior						
-	-	DSI-1630-30-25I	DSI-1630-30-25E	314	250	66	0.8 kg	1 pc	10 pcs
-	-	DSI-1630-30-35I	DSI-1630-30-35E	430	350	74	1.2 kg		
-	-	DSI-1630-30-45I	DSI-1630-30-45E	542	450	80	1.5 kg		
-	-	DSI-1630-30-60I	DSI-1630-30-60E	721	600	79	1.8 kg		

MOUNTING KIT FOR DSI SERIES DOOR HANDLES

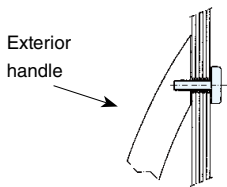

Installation for Wood/Metal/Glass door

Max. Door thickness:

- | | |
|---------------------|---------------------|
| DSI-1630-30: 100 mm | DSI-3310-30: 60 mm |
| DSI-2000-20: 80 mm | DSI-3330-30: 100 mm |
| DSI-2000-30: 80 mm | DSI-4400-15: 60 mm |
| DSI-3310-15: 60 mm | DSI-4400-20: 60 mm |
| DSI-3310-20: 60 mm | DSI-4400-30: 60 mm |

Item Code	Item Name	For Use With
-	DKIT-2/15-1	DSI-3310-15
-	DKIT-2/15-2	DSI-4400-15
-	DKIT-2/20-1	DSI-2000-20/DSI-3310-20
-	DKIT-2/20-2	DSI-4400-20
-	DKIT-2/30-1	DSI-1630-30/DSI-2000-30/DSI-3310-30/DSI-3330-30
-	DKIT-2/30-2	DSI-4400-30

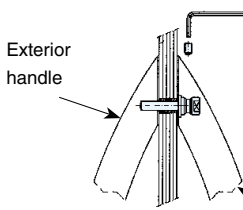

Installation for Back-to-back Mount

Max. Door thickness:

- | | |
|---------------------|---------------------|
| DSI-1630-30: 90 mm | DSI-3310-30: 100 mm |
| DSI-2000-20: 100 mm | DSI-3330-30: 100 mm |
| DSI-2000-30: 45 mm | DSI-4440-15: 100 mm |
| DSI-3310-15: 100 mm | DSI-4440-20: 100 mm |
| DSI-3310-20: 100 mm | DSI-4440-30: 100 mm |

Item Code	Item Name	For Use With
-	DKIT-4/15-1	DSI-3310-15
-	DKIT-4/15-2	DSI-4400-15
-	DKIT-4/20-1	DSI-2000-20/DSI-3310-20
-	DKIT-4/20-2	DSI-4400-20
-	DKIT-4/30-1	DSI-1630-30/DSI-2000-30/DSI-3310-30/DSI-3330-30
-	DKIT-4/30-2	DSI-4400-30

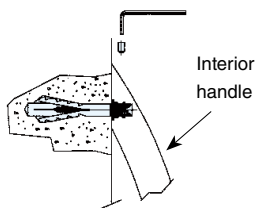

Installation for Wall-mount or Concrete

Item Code	Item Name	For Use With
-	DKIT-5/15	DSI-3310-15/DSI-4400-15
-	DKIT-5/20	DSI-2000-20/DSI-3310-20/DSI-4400-20
-	DKIT-5/30	DSI-1630-30/DSI-2000-30/DSI-3310-30/DSI-3330-30/DSI-4400-30